

POWER CONTROL



Information

IC ELECTRONIC was established in 1995 and the company has set-up a new and innovative standard in industrial semiconductor technology founded on the knowledge of its experienced and skilful team of employees.

The research and development is a combination of many years of experience within the field of power electronics and industrial applications.

IC ELECTRONIC has developed a unique programme of electronic contactors and motor controllers.

The product range is sold under the name of P-Line or as private labelled in more than 130 countries world-wide.

QUALITY

Our research and development activities combine experience and ingenuity in extending technological boundaries in new products as well as existing ones. Quality is integrated in design and production. The direct copper bonded ceramic base makes a stable connection for the semiconductor chip.

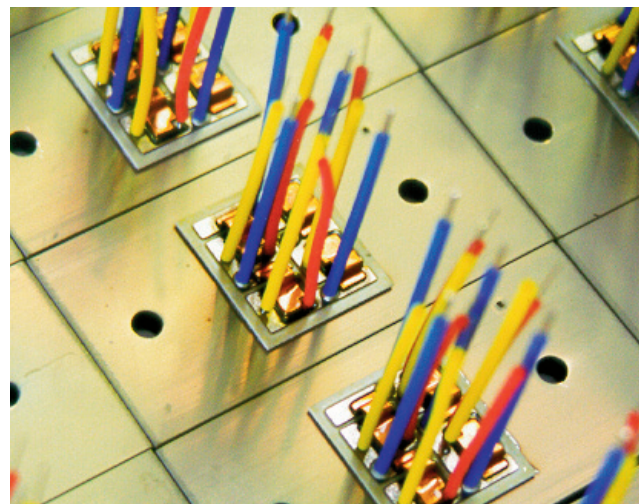

MISSION

As a world class manufacturer our mission is to design, produce and sell advanced power electronics, semiconductor contactors and motorcontrollers for power and motor applications to the industry
ALL OVER THE WORLD

IC-ELECTRONIC is owned by Montra Foundation



TECHNOLOGY

We have implemented the latest technology in design and manufacturing of power electronics. The products meet the requirements of international standards EN 60947-4-2 / EN 60947-4-3) and are approved according to CE and cULus.

IC Electronic A/S is ISO 9001 Certified.



APPLICATIONS

Our range of products offer solutions for almost any power control application. The product family consists of components designed for electrically harsh industrial applications. All necessary protection is integrated at different utilization categories.

CONTENTS

SELECTION / APPLICATION GUIDE

Motor applications	Page 4
Heating control applications	Page 4-5
Heating control (analogue)	Page 5
Lamp/Transformer control	Page 5

SOFT STARTERS

Soft starter (three phase controlled)	Page 6-7
Soft starter (two phase controlled)	Page 8-9
Soft starter technical information	Page 10-11
Starting Torque Limiter (one phase controlled)	Page 12-13
Soft starter with dynamic brake	Page 14-15
Technical information dynamic brake	Page 16-17
Reversing motor contactor	Page 18-19
Direct On Line motor controller	Page 20-21

AC ELECTRONIC CONTACTORS

Single phase contactor	Page 22-23
Single phase contactor heatingelement	Page 24-25
Single phase contactor (domestic applications)	Page 26-27
Dual phase contactor	Page 28-29
Dual phase contactor heatingelement	Page 30-31
Three phase contactor heatingelement	Page 32-33
Three phase contactor	Page 34-35
Three phase contactor heatingelement	Page 36-37
Analogue power controller	Page 38-39
Technical information analogue controller	Page 40-41
Auxiliary contact module	Page 42-43

GENERAL INFORMATION

Dimensions and weight	Page 44
Mounting instructions /Cable wiring	Page 45
Index	Page 46-47

Application guide

Soft starter for 3-phase motors

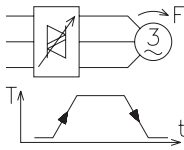

Application: Control of material transportation, conveyer, cranes, Soft Start / Soft Stop. Type SMC 3/33
Further information on page: 6-11

Soft starter with dynamic brake for 3-phase motors

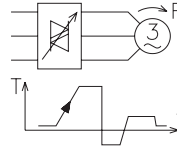

Application: Soft Start and braking of e.g. woodworking machines. Type SMBC3.
Further information on page: 14-15

Reversing of 3-phase motors

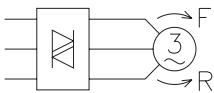

Application: Control of material transportation, conveyer cranes. Reversing. Type SRC3.
Further information on page: 18-19

Inching and jogging of 3-Phase motors

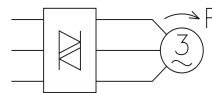

Application: Control of general machine positioning. Direct On Line Start (DOL) for inching, jogging and frequent switching. Type SMC3 DOL.
Further information on page: 20-21

Starting torque limiter for 3-phase motors

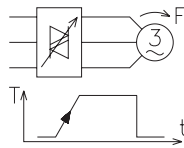

Application: General machine positioning, Soft Start, reduction of mechanical shock. Type STL3.
Further information on page: 12-13

Starting torque limiter for 1-phase motors

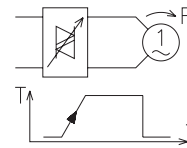

Application: General machine positioning, reduction of mechanical shock. Type STL1.
Further information on page: 12-13

Electronic contactor for 3-phase motors

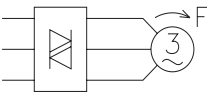

Application: Control of general machine positioning, frequent switching. Type SC3.
Further information on page: 34-35

Electronic contactor for 1-phase motors

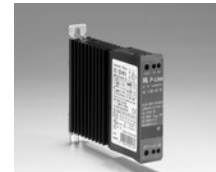
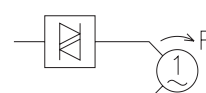

Application: Control of general machine positioning, frequent switching. Type SC1.
Further information on page: 22-23

Electronic contactor for heating control 1-ph.

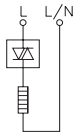

Application: Switching of 1-phase heaters in industrial temperature applications. Type SC1 / RC11
Further information on page: 22-25

Electronic contactor for heating control 3-ph. (with neutral)

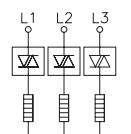

Application: Switching of 3-phase heaters in industrial temperature applications 3-phase with neutral. Type SC1x3 / RC11x3
Further information on page: 22-25

Electronic contactor for heating control 3-ph. (without neutral)

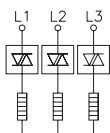

Application: Switching of 3-phase heaters in industrial temperature applications 3-phase without neutral. Type SC1x3 / RC11x3
Further information on page: 22-25

Electronic contactor for heating control 3-ph. (without neutral) Economical circuit

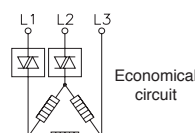

Application: Switching of 3-phase heaters in industrial temperature applications 3-phase without neutral. Economical circuit, two phases switched. SC1x2/SC2x1. og RC11x 2 /RC22x1 / RC32x1. Further information on page: 22-25 / 28-33

Application guide

Electronic contactor for heating control 3-ph. (without neutral)

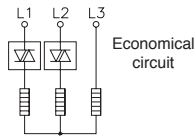

Application: Switching of 3-phase heaters in industrial temperature applications without neutral. Economical circuit, two phases switched. Type SC1x2 / SC2x1. RC11x1 / RC22x1 / RC32x1. Further information on page: 22-25 / 28-33

Electronic contactor for heating control 3-ph. (with neutral)

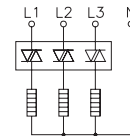

Application: Switching of 3-phase heaters On/Off in industrial temperature applications 3-phase with neutral. Type SC3 / RC33. Further information on page: 34-37

Electronic contactor for heating control 3-ph. (without neutral)

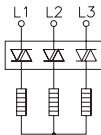

Application: Switching of 3-phase heaters in industrial temperature applications 3-phase without neutral. Type SC3 / RC33. Further information on page: 34-37

Electronic contactor for heating control 1-ph.

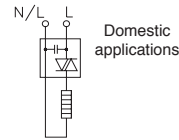

Application: Switching of 1-phase heaters On/Off in domestic temperature applications EN50081-1/ EN50082-2. Type SC1L. Further information on page: 26-27

Electronic contactor for heating control 3-ph. (with neutral)

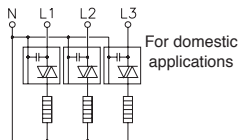

Application: Switching of 3-phase heaters On/Off in domestic temperature applications EN50081-1/ EN50082-2. Type SC1Lx3. Further information on page: 26-27

Electronic contactor for heating control 3-ph. (without neutral)

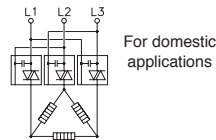

Application: Switching of 3-phase heaters On/Off in domestic temperature applications EN50081-1 / EN50082-2. Type SC1Lx3. Further information on page: 26-27

Analogue control of 1ph. heaters

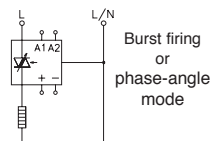

Application: Analogue control of 1-phase heaters in phase angle or burst firing mode. Type SPC1. Further information on page: 38-41

Analogue control of 3-ph. heaters (with neutral)

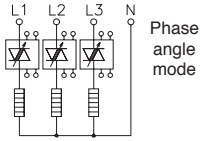

Application: Analogue control of 3-phase heaters in phase angle mode. Type SPC1x3. Further information on page: 38-41

Analogue control of 3-ph. heaters

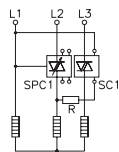

Application: Analogue control of 3-phase heaters with 1-pole contactor. Type SPC1x1/SC1x1 / RC11x1 in slave circuit and burst firing mode. Further information on page: 38-41 / 22-25

Control of incandescent or metal vapour lamps

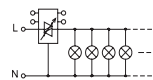

Application: Lamp load analogue control of incandescent lamps. Type SPC1 or type SC1. Further information on page: 38-41

Soft start of 3-ph. or On/Off control 1-ph. transformer

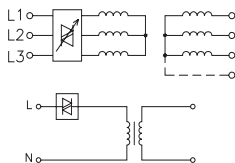

Application: Transformer load control of 3-phase transformer with soft start. Type SMC. Transformer load controlled of 1-phase electronic contactor. Type SC1. Further information on page: 6-11 / 22-23

Analogue control of 1-ph. transformers

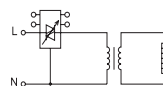

Application: Transformer load controlled of 1-phase analogue power controller. Type SPC1. Further information on page: 38-41

Soft Starter (SMC 33 / three controlled phases)



- Rated operational voltage up to 480 VAC 50/60Hz
- Rated operational current up to 86A (inside delta DBP)
- Output signal for By-Pass and Start/Stop
- Ramp Up and Down time adjustable
- Initial Torque adjustable with kick start
- Wide control voltage range
- Meets EN 60947-4-2 requirements
- High number of start/stop operations pr. hour. See data.

Item selection and technical specifications (see also motor table at page 11)

Load ratings	Item number by 208-240VAC 50/60Hz Line Voltage	Item number by 400-480VAC 50/60Hz Line Voltage	Item number by 550-600VAC 50/60Hz Line Voltage	Ramp-Up / Down adjustment	Torque adjustment	Module-width
¹ Inside delta configuration						
15A AC-53a		SMC 33 DA 4015				90 mm
15A AC-53a no by-pass		SMC 33 DA 4025BP				90 mm
27A AC-53b w. by-pass		SMC 33 DA 4025BP				90 mm
* 35A AC-53a no by-pass	SMC 33 DA 2350BP*	SMC 33 DA 4050BP*		Ramp-up time 0.5 - 30 sec.	0- 85% adjustable of nominal torque with selectable kick start 200ms (break loose function)	180 mm
* 50A AC-53b w. by-pass	SMC 33 DA 2350BP*	SMC 33 DA 4050BP*				180 mm
Items for Inside delta configuration						
¹ 25A AC-53a no by-pass		SMC 33 DA 4040DBP		Ramp-down time 0.5 - 60 sec.		90 mm
¹ 43A AC-53b w. by-pass		SMC 33 DA 4040DBP				90 mm
* ¹ 60A AC-53a no by-pass	SMC 33 DA 2385DBP*	SMC 33 DA 4085DBP*				180 mm
* ¹ 86A AC-53b w. by-pass	SMC 33 DA 2385DBP*	SMC 33 DA 4085DBP*				180 mm

Load specified with utilisation category AC-53a

SMC 33 DA XXXX **BP** AC-53a: No by-pass contactors is necessary during running, shall be connected as inline configuration

SMC 33 DA XXXX **DBP** AC-53a: No by-pass contactors is necessary but motor shall be connected in an inside-delta configuration

Load specified with utilisation category AC53b

SMC 33 DA XXXX **BP** AC-53b: By-pass contactor shall be used for bypassing the soft starter during running, shall be connected as inline configuration

SMC 33 DA XXXX **DBP** AC-53b: By-pass contactor shall be used and motor connected in an inside-delta configuration

Output load specification (90mm module) more info page 45

Overload current profile AC-53a (without by-pass contactor)	X-Tx:6-5 : 100-120
Overload current profile AC-53b (with by-pass contactor)	X-Tx:5-5 : 30
Overload relay trip class AC-53a/AC53b	10 or 10A

Leakage current: 5mA ACmax. Min. operational current: 50mA

Output load specification (180mm module) more info page 45

Overload current profile AC-53a (without by-pass contactor)	X-Tx:6-6 : 100-120
Overload current profile AC-53b (with by-pass contactor)	X-Tx:6-6 : 30
Overload relay trip class AC-53a/AC53b	10 or 10A

Leakage current: 5mA ACmax. Min. operational current: 50mA

Control terminal specifications

Control voltage by line voltage 208-240VAC A1-A2	24 - 230 VAC/DC
Control voltage by line voltage 400-600VAC A1-A2	24 - 480 VAC/DC
Pick-up voltage max.	20.4 VAC/DC
Drop-out voltage min.	5 VAC/DC
Max. control current for no operation	1mA
Response time max.	70msec.
Control current / power max.	15mA / 2VA

Auxiliary contacts

Terminal: 13-14, AC SCR output for start/stop function,
Terminal: 23-24, AC SCR output for connection of by-pass contactor.

Output specifications for 90mm module: AC SCR: 0.5A AC-14, AC15 24-230/480V AC 50-60Hz Fusing: gl/gG Max i²t 72A²S

Output specifications for 180mm module: AC SCR: 1.0A AC-14, AC15 24-230/480V AC 50-60Hz Fusing: gl/gG Max i²t 72A²S

Terminal: 11-12, have no connection with the internal circuit. Can be used in conjunction with a thermal overload protection or for other wiring purposes. See under general technical information.

Thermal specification

Power dissipation for continuous operation PDmax	3 W/A without BP
Power dissipation with semiconductor by-passed	5 W Max. with BP
Cooling method	Natural convection
Mounting	Vertical +/-30°
Operating temperature range EN 60947-4-2	-5°C to 40°C
Max. operating temperature with current derating	60°C
Storage temperature EN 60947-4-2	-20°C to 80°C

Operation in ambient temperatures exceeding 40°C is possible if the power dissipation is limited either by reducing the steady-state current or by reducing the duty-cycle of the soft starter as shown in the table. Max.cycle time 15min.

By 40°C	By 50°C	By 60°C
100% load Duty-cycle 100%	80% load Duty-cycle max. 0,8	70% load Duty-cycle max. 0,65

* NOT cUL APPROVED

Specifications are subject to change without notice



Soft Starter (SMC 33 / three controlled phases)

Wiring specifications (90mm module)

11-12: for UP62 or other wiring purposes

Control voltage A1-A2

Output 13-14:
For control of Start/Stop function
Do not include SMC 33 DA XX15

Output 23-24:
By end of ramp up time for by-pass contactor
Do not include SMC 33 DA XX15

Wiring specifications (180mm module)

11-12: for UP62 or other wiring purposes

Output 13-14:
For control of Start/Stop function

Control voltage A1-A2

Output 23-24:
By end of ramp up time for by-pass contactor

Wiring information: Delta configuration

Standard wiring of a softstarter to a 3-phase motor in delta configuration.

*Use UL approved Magnetic Circuit Breaker or UL specified back-up fuse type KS or H Class

Wiring information: Inside-delta configuration

Inside-delta wiring of a softstarter to a 3-phase motor.

*Use UL approved Magnetic Circuit Breaker or UL specified back-up fuse type KS or H Class

Wiring example Start/Stop - By-pass (90 mm modul)

Auxiliary SCR output contact 13-14 (AC voltage only) is used for controlling a Start-Stop function directly wired to the soft starter.
Auxiliary SRC output contact 23-24 (AC voltage only) is activated when the ramp-up time has elapsed. Is used for by-passing the soft starter with an external connected electromechanical contactor.

Wiring example Start/Stop - By-pass (180 mm modul)

Auxiliary SCR output contact 13-14 (AC voltage only) is used for controlling a Start-Stop function directly wired to the soft starter.
Auxiliary SRC output contact 23-24 (AC voltage only) is activated when the ramp-up time has elapsed. Is used for by-passing the soft starter with an external connected electromechanical contactor.

Short-circuit protection by circuit breaker or fuses

Two type of short-circuit protection can be used:

- Short-circuit protection by circuit breaker.
- Short-circuit protection by fuses.

Short-circuit protection is divided into 2 levels **Type 1** or **Type 2**

Co-ordination Type1: Short-circuit protects the installation

Co-ordination Type 2: Short-circuit protects the installation and the semi-conductors inside the motor controller

a) Short-circuit protection

Co-ordination type 1 will be obtained when using magnetic circuit breakers or standard gl/GI fuses.
Co-ordination type 2 will be obtained when using semiconductor fuses. When using semiconductor fuses the SCR will not be damaged due to transients and short circuits. The table indicates suitable fuses for co-ordination type 2 protection.

b) Short-circuit protection by fuses

Type 1: SMC 33 DA XX15	Protection max. 50 A gL/gG
Type 1: SMC 33 DA XX25 BP	Protection max. 80 A gL/gG
Type 1: SMC 33 DA XX40 DBP	Protection max. 80 A gL/gG
Type 1: SMC 33 DA XX50 BP	Protection max. 125 A gL/gG
Type 1: SMC 33 DA XX85 DBP	Protection max. 125 A gL/gG
Type 2: SMC 33 DA XX15	Protection max. i^2t of the fuse 1800 A ² S
Type 2: SMC 33 DA XX25 BP	Protection max. i^2t of the fuse 6300 A ² S
Type 2: SMC 33 DA XX40 DBP	Protection max. i^2t of the fuse 6300 A ² S
Type 2: SMC 33 DA XX50 BP	Protection max. i^2t of the fuse 25300 A ² S
Type 2: SMC 33 DA XX85 DBP	Protection max. i^2t of the fuse 25300 A ² S

Fuses from e.g. Ferraz, Siba, Bussmann can be used as short-circuit protection Type 2

More information concerning Co-ordination Type 2 see page 45

Approval

cUL Std No. 508 (Not approved SMC 33 DA XX50BP and SMC 33 DA XX85DBP)

Application, adjustment hints and general specifications

See page 10-11 / 44-45

Soft Starter (SMC 3 / SMC 32 two controlled phases)



- Rated operational voltage up to 600 VAC 50/60Hz
- Rated operational current up to 25A/30A
- Output signal for By-Pass and Start/Stop
- Ramp Up and Down time adjustable
- Initial Torque adjustable with kick start
- Wide control voltage range
- Meets EN 60947-4-2 requirements
- High number of start/stop operations pr. hour. See data

Item selection and technical specifications (see also motor table at page 11)

Load ratings	Item number by 208-240VAC 50/60Hz Line Voltage	Item number by 400-480VAC 50/60Hz Line Voltage	Item number by 550-600VAC 50/60Hz Line Voltage	Ramp-Up / Down adjustment	Torque adjustment	Module-width
Items with built-in by-pass relays						
3.5A AC-53b	SMC 3 DA 2303	SMC 3 DA 4003 415V	SMC 3 DA 6003	Ramp-up time 0.5 - 10 sec. Ramp-down time 0.5 - 10 sec.	0- 85% adjustable of nominal torque with selectable kick start 200ms (break loose function)	22.5mm
3.5A AC-53b		SMC 3 DA 4803 480V				22.5mm
15A AC-53b		SMC 32 DA 4015BP 415V*				45mm
15A AC-53b						45mm
Items for 100% duty-cycle (AC-53a)						
15A AC-53a	SMC 3 DA 2315	SMC 3 DA 4015	SMC 3 DA 6015	Ramp-up / Ramp down time 0.5 - 20 sec.		45mm
25A AC-53a	SMC 3 DA 2325	SMC 3 DA 4025	SMC 3 DA 6025			90mm
25A AC-53a	SMC 3 DA 2325BP	SMC 3 DA 4025BP	SMC 3 DA 6025BP	Ramp-up / Ramp down time 0.5 - 20 sec.		90mm
27A AC-53b w. by-pass	SMC 3 DA 2325BP	SMC 3 DA 4025BP	SMC 3 DA 6025BP			90mm

Output current profile

SMC 3 DA XX03 / SMC 32 DA XX15BP AC-53b	More info. page 45	SMC 3 DA XX25BP AC-53a / AC-53b	More info. page 45
Overload current profile XX03 (with internal by-pass relay)	X-Tx:4-10 : 110	Overload current profile (without by-pass contactor)	X-Tx:6-5 : 100-120
Overload current profile XX15BP (with internal by-pass relay)	X-Tx:8-3 : 110	Overload current profile (with by-pass contactor)	X-Tx:5-5 : 30
Overload relay trip class	10 or 10A	Overload relay trip class	10 or 10A
SMC 3 DA XX15/25 AC-53a	More info. page 45	SMC 3 DA 4025BP	*Note: External by-pass contactor shall be used for bypassing the soft starter during running by 27A/15kW load @400V.
Overload current profile	X-Tx:8-3 : 100-3000		
Overload relay trip class	10 or 10A		
SMC 3: Leakage current: 5mA ACmax. / Min. operational current: 50mA		SMC 32: Leakage current: 5mA ACmax. / Min. operational current: 50mA	

Control voltage specifications

Control voltage by line voltage 208-240VAC A1-A2	24 - 230 VAC/DC
Control voltage by line voltage 400-600VAC A1-A2	24 - 480 VAC/DC
Pick-up voltage max.	20.4 VAC/DC
Drop-out voltage min.	5 VAC/DC
Max. control current for no operation	1mA
Response time max.	70msec.
Control current / power max.	15mA / 2VA

AC auxiliary contacts / SMC 3 DA XX25BP

Auxiliary specifications:
Terminal: 13-14 , AC SCR Output for start/stop function, Terminal: 23-24 , AC SCR Output for connection of by-pass contactor.
Load specifications: AC SCR: 0.5A AC-14, AC-15 24-230/480VAC 50-60Hz Fusing: gl/gG Max i ² t 72A ² S
General for terminal: 11-12 , have no connection with the internal circuit. Can be used in conjunction with a thermal overload protection or for other wiring purposes. See general technical information.

Common thermal specifications

Power dissipation for continuous operation PDmax	2 W/A without BP	Operation in ambient temperatures exceeding 40°C is possible if the power dissipation is limited either by reducing the steady-state current or by reducing the duty-cycle of the soft starter as shown in the table. Max.cycle time 15min. Note: SMC 3 DA XX03 / SMC 32 DA XX15BP see page 45.
Power dissipation with semiconductor by-passed	4 W Max.	
Cooling method	Natural convection	
Mounting	Vertical +/-30°	
Operating temperature range EN 60947-4-2	-5°C to 40°C	
Max. operating temperature with current derating	60°C	
Storage temperature EN 60947-4-2	-20°C to 80°C	
		By 40°C
		By 50°C
		By 60°C
		100% load Duty-cycle 100%
		80% load Duty-cycle max. 0.8
		70% load Duty-cycle max. 0.65

* NOT cUL APPROVED

Soft Starter (SMC 3 / SMC 32 two controlled phases)

Wiring specifications

SMC 3 DA XX03 SMC 32 DA XX15BP

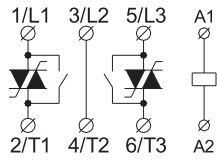

Control voltage A1-A2

SMC 3 DA XX15/25 11-12: for UP62 or other wiring purposes

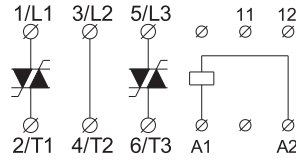

SMC 3 DA XX25 BP

11-12: for UP62 or other wiring purposes

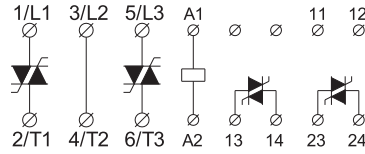

Control voltage A1-A2 Output 13-14: For control of Start/Stop function Output 23-24: By end of ramp up time for by-pass contactor

Wiring example Start/Stop-By-pass (SMC 3 DA XX25 BP)

Auxiliary SCR output contact 13 - 14 (AC voltage only) is used for controlling a Start-Stop function directly wired to the soft starter. Auxiliary SRC output contact 23-24 (AC voltage only) is activated when the ramp-up time has elapsed. Is used for by-passing the soft starter with an external connected electromechanical contactor.

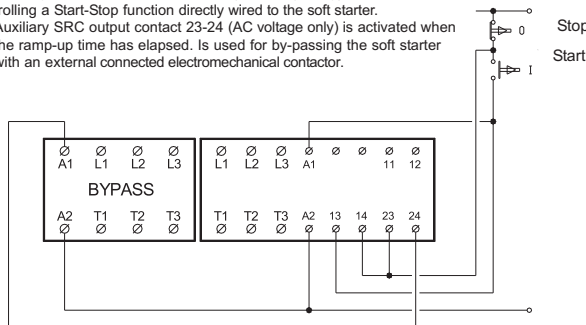

Motor wiring with or without by-pass (SMC 3 DA XX25 BP)

Standard wiring of a softstarter to a 3-phase motor in delta configuration.

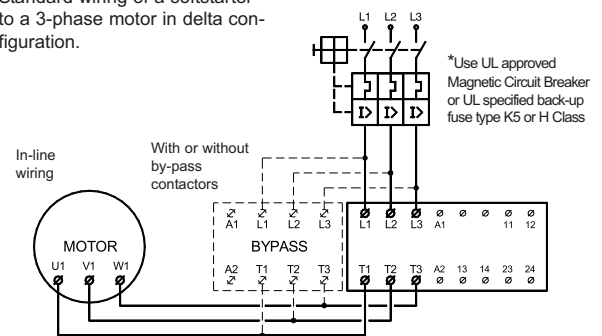

Short-circuit protection by circuit breaker or fuses

Two type of short-circuit protection can be used:

- Short-circuit protection by circuit breaker.
- Short-circuit protection by fuses.

Short-circuit protection is divided into 2 levels **Type 1** or **Type 2**

Co-ordination Type 1: Short-circuit protects the installation

Co-ordination Type 2: Short-circuit protects the installation and the semi-conductors inside the motor controller

a) Short-circuit protection

Co-ordination type 1 will be obtained when using magnetic circuit breakers or standard gI/GI fuses.

Co-ordination type 2 will be obtained when using semiconductor fuses. When using semiconductor fuses the SCR will not be damaged due to transients and short circuits. The table indicates suitable fuses for co-ordination type 2 protection.

b) Short-circuit protection by fuses

Type 1: SMC 3 DA XX03	Protection max. 25 A. gL/gG
Type 1: SMC 32 DA XX15 BP	Protection max. 50 A. gL/gG 63A T
Type 1: SMC 3 DA XX15	Protection max. 50 A. gL/gG 63A T
Type 1: SMC 3 DA XX25	Protection max. 80 A. gL/gG 63A T
Type 1: SMC 3 DA XX25 BP	Protection max. 80 A. gL/gG 63A T

Type 2: SMC 3 DA XX03	Protection max. i^2t of the fuse 72 A ² S
Type 2: SMC 32 DA XX15 BP	Protection max. i^2t of the fuse 1800 A ² S
Type 2: SMC 3 DA XX15	Protection max. i^2t of the fuse 1800 A ² S
Type 2: SMC 3 DA XX25	Protection max. i^2t of the fuse 6300 A ² S
Type 2: SMC 3 DA XX25 BP	Protection max. i^2t of the fuse 6300 A ² S

Fuses from e.g. Ferraz, Siba, Bussmann can be used as short-circuit protection Type 2

More information concerning Co-ordination Type 2 see page 45

Approval

cUL Std No. 508

Application, adjustment hints and general specifications

See page 10-11 / 44-45

Dimensions (see also page 44)

Type	H	D	W
22.5 mm module	94 mm	123.8 mm	22.5 mm
45 mm module	94 mm	128.1 mm	45 mm
90 mm module	94 mm	128.1 mm	90 mm

Application, adjustment hints and general specifications for SMC 3/32/33

Input controlled soft-start

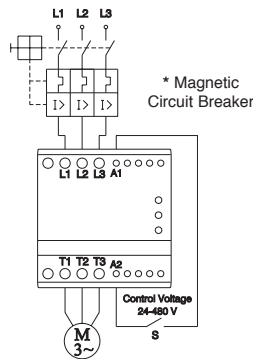

When the control input is switched to the ON-state (S closed) the motor controller will soft start the motor according to the settings of the ramp-up time and initial torque adjustments.

When the control input is switched to the Off-state (S open) the motor will be switched Off instantaneously only if the Ramp-Down time is adjusted to 0.

With any other setting the motor will be soft stopped according to the settings of the Ramp-Down time adjustment.

*Use UL approved Magnetic Circuit Breaker or UL specified back-up fuse type K5 or H Class

Line controlled soft-start

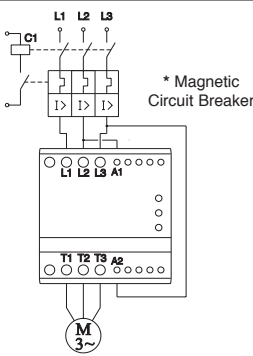

When the contactor C1 is switched to the ON-state, the motor controller will soft start the motor according to the settings of the ramp-up time and initial torque adjustments.

When the contactor C1 is switched to the OFF-state, the motor will be switched Off instantaneously.

In this application the contactor will have no load during making operation. The contactor will carry and break the nominal motor current when switching off.

*Use UL approved Magnetic Circuit Breaker or UL specified back-up fuse type K5 or H Class

*UL: Use thermal overload protection as required by the National Electric Code. When protected by a non-time delay K5 or H Class fuse, rated 266% of motor FLA, this device is rated for use on a circuit capable of delivering not more than 5,000 rms. symmetrical amperes, 600 V maximum. Maximum surrounding temperature 40°C.

Thermal overload protection (see also page 44)

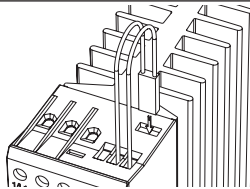

Optional thermal overload protection is possible by inserting a thermostat in a slot on the right hand side of the soft starter. Type number UP62

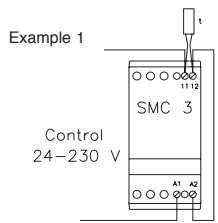

The thermostat can be connected in series with the control circuit of the soft starter.

When the temperature of the heatsink exceeds 90°C the soft starter will switch Off.

Note: When the temperature has dropped approx. 30°C the soft starter will automatically be switched on again.

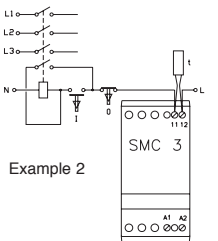

The thermostat is connected in series with the control circuit of the main contactor.

Note: When the temperature of the heatsink exceeds 90°C the main contactor will switch Off. A manual reset is necessary to restart this circuit.

Dimensions (see also page 44)

Type	H	D	W
22.5 mm module	94 mm	123.1 mm	22.5 mm
45 mm module	94 mm	128.1 mm	45 mm
90 mm module	94 mm	128.1 mm	90 mm
180 mm module	140 mm	144.8 mm	180 mm

Combining Reversing Breaker Electronic Contactor & Soft Starter

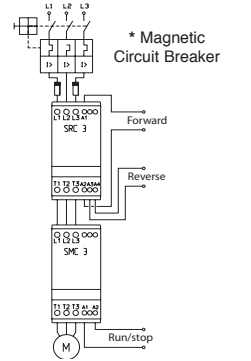

Soft-reversing of motors up to 10A

A Soft-Reversing of a motor can easily be achieved by connecting a reversing relay to the Soft Starter. The reversing relay type SRC 3 DX will determine the direction of rotation Forward or Reverse and the Soft Starter type SMC 3/32/33 will perform soft-starting and soft-stopping of the motor.

If soft-stop is not required the application can be simplified by connecting the control circuit of the Soft Starter to the main terminals as shown under Line Controlled Soft-Start. A delay of approx. 0.5 sec. between forward and reverse control signal must be allowed to avoid influence from the voltage generated by the motor during turn Off.

Combining reversing mechanical contactor & soft starter

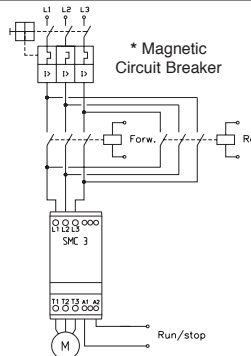

Soft-reversing of motors up to 85A

A Soft-Reversing of motors can easily be achieved when the motor load exceeds 10A by connecting a mechanical reversing contactor to the Soft Starter. The reversing contactor will determine the direction of rotation forward or reverse and the Soft Starter type SMC3/32/33 will perform soft-starting and soft-stopping of the motor.

If the contactors are always switched in no load conditions the lifetime of the contactors will normally exceed 10 million cycles.

Insulation specifications

Rated insulation voltage	Ui 660 Volt
Rated impulse withstand voltage	Uimp. 4 kVolt
Installation category	III

Environment

Degree of protection	IP 20	Pollution degree	3
----------------------	-------	------------------	---

EMC

These components meets the requirements of the product standard EN60947-4-2 and is CE marked according to this standard. They are designed for class A equipment. Use of the product in domestic environments may cause radio interference, in which case the user may be required to employ additional mitigation methods.

Functional diagram

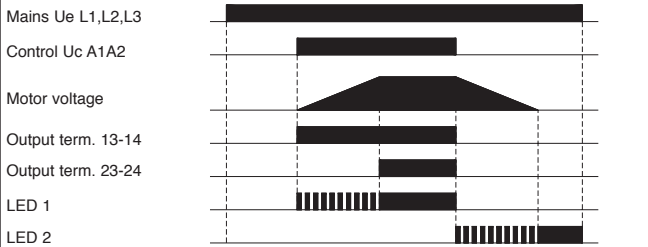

Output: Terminal 13-14 Start-Stop (AC voltage only)
For control of Start-Stop function directly wired to the soft starter

Output: Terminal 23-24 By-Pass (AC voltage only)
For signalling Full-On state. By-Pass in AC-53b operation

LED information:
Note: When both LED's are flashing, no connection to the motor (SMC 3 only)
Note: When both LED's are flashing, one phase is missing (SMC 33 only)

Mounting and cable wiring information

Mounting information see page 44
Cable wiring see page 45

Application, adjustment hints and general specifications for SMC 3/32/33

How to adjust ramp times and initial torque

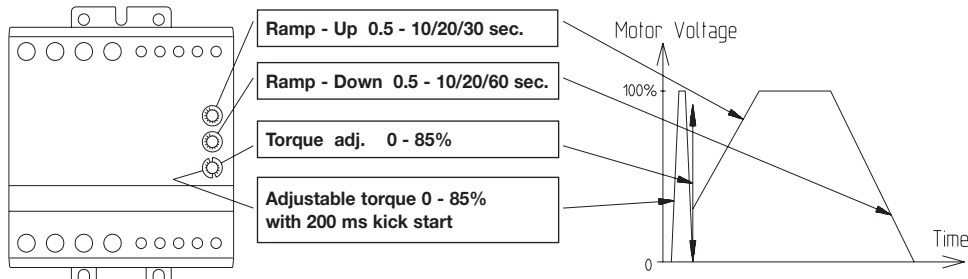

A. Ramp-Up time and initial torque (standard load)

- A1) Set the *Ramp-Up* switch to maximum.
- A2) Set the *Ramp-Down* switch to minimum.
- A3) Set the *Initial Torque* switch to minimum.
- A4) Apply control signal for a few seconds. If the load does not rotate immediately increment the *Initial Torque* and try again. Repeat until the load starts to rotate immediately on start-up.
- A5) Adjust *Ramp-Up* time to the estimated start time (scale is in seconds) and start the motor.
- A6) Decrease the *Ram-Up* time until mechanical surge is observed during start.
- A7) Increase the time one step to eliminate the surge.

B. Kick-Start / Break loose. High inertia loads.

If it is not possible to reach a time sufficient for the application (step A7) it may be necessary to kick-start the load.

- B1) Set the *Ramp-Up* switch to maximum.
- B2) Set the *Ramp-Down* switch to minimum.
- B3) Set the *Initial Torque* switch to minimum Kick-start torque.
- B4) Apply control signal for a few sec. If the load stops right after the 200 ms "kick" increment the initial torque and try again. Repeat until the load continues to rotate after the "kick"
- B5) Adjust *Ramp-Up* time to the desired start time (the scale is in seconds) and start the motor.

C. Ramp-Down time. E.g. Pump loads

Follow procedure A or B to set *Ramp-Up* and *initial torque*

- C1). Set the *Ramp-Down* switch to maximum.
- C2) Switch off the control voltage and observe any mechanical surges on the load. If none decrement *Ramp-Down* switch and try again. Repeat until mechanical surges on the load is observed.
- C3) Increase the time one step to eliminate the surge.

Note:

- a) Control of the motor torque is achieved by acting on the motor voltage. The motor speed depends on the torque produced by the motor and the load on the motor shaft.
- b) A motor with little or no load will reach full speed before the voltage has reached its maximum value.
- c) The soft starter will read time and torque settings in the off state. Repeated starts may trip the motor protection relay.
- d) Make sure NOT to set the rotary switches in between positions as this corrupts the time and torque adjustment. Use screwdriver 2 mm x 0.5 mm

Typical motor current by different line voltages

kW	HP	220-230 VAC	380-400 VAC	415 VAC	440 VAC	460-480 VAC	600 VAC
0.37	0.5	1.8 A	1 A	1 A	1 A	1 A	1 A
0.55	0.75	2.75 A	1.6 A	1.5 A	1.4 A	1.4 A	1.1 A
0.75	1	3.5 A	2 A	2 A	1.7 A	1.7 A	1.3 A
1.1	1.5	4.4 A	2.6 A	2.5 A	2.4 A	2.4 A	1.8 A
1.5	2	6.1 A	3.5 A	3.5 A	3.1 A	3 A	2.3 A
2.2	3	8.7 A	5 A	5 A	4.5 A	4.4 A	3.4 A
3	4	11.5 A	6.6 A	6.5 A	5.8 A	5.6 A	4.3 A
4	5	14.5 A	8.5 A	8.3 A	8 A	7.8 A	6 A
5.5	7.5	20 A	11.5 A	11 A	10.4 A	10 A	7.7 A
7.5	10	27 A	15.5 A	14 A	13.7 A	13 A	10 A
11	15	39 A	22 A	21 A	20 A	19 A	15 A
15	20	52 A	30 A	28 A	26 A	25 A	20 A
18.5	25	64 A	37 A	35 A	33 A	32 A	25 A
22	30	75 A	43 A	40 A	38 A	36 A	28 A
30	40		58 A	54 A	52 A	50 A	38 A
37	50		70 A	64 A	61 A	59 A	45 A
45	60		83 A	78 A	75 A	73 A	56 A

Starting Torque Limiter (STL Soft Starter for 1&3-phase motors, one controlled phase)

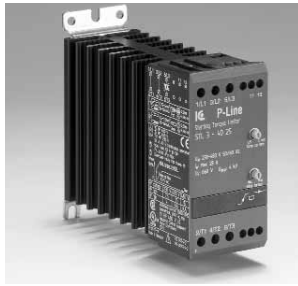

- Rated operational voltage up to 690 VAC 50/60 Hz
- Rated operational current: 15 Amp or 25 Amp
- Ramp Up adjustable from 0.5-5 sec
- Initial torque adjustable from 0-85%
- LED status indication
- Meets EN 60947-4-2 requirements
- High number of start/stop operations pr. hour. See data

Item selection and technical specifications (see also motor table at page 11)

Load ratings	Item number by 110-127VAC 50/60Hz Line Voltage	Item number by 208-480VAC 50/60Hz Line Voltage	Item number by 550-600VAC 50/60Hz Line Voltage	Item number by 550-690VAC 50/60Hz Line Voltage	Ramp-Up adjustment	Torque adjustment	Module-width
Items for 1-phase motors					Ramp-up time 0.5 - 5 sec.	0- 85% adjustable of nominal torque	45mm
15A AC-53a	STL 1 1215	STL 1 4015	STL 1 6015				
25A AC-53a	STL 1 1225	STL 1 4025	STL 1 6025				
Items for 3-phase motors							
15A AC-53a	STL 3 1215	STL 3 4015	STL 3 6015	STL 3 6925 * #		45mm	
25A AC-53a	STL 3 1225	STL 3 4025	STL 3 6025				

Load specified with utilisation category AC-53a

STL 1 and 3 XX/15/25 AC-53a:
No by-pass contactors is necessary during running

Output load specification

STL 1 and 3 XX15	More info. page 45	STL 1 and 3 XX25	More info. page 45
Overload current profile AC-53a	X-Tx:8-3 : 100-3000	Overload current profile AC-53a	X-Tx:8-3 : 100-3000
Overload relay trip class AC-53a	10 or 10A	Overload relay trip class AC-53a	10 or 10A
Min. operational current: 50mA		Min. operational current: 50mA	

Thermal specification

Power dissipation for continuous operation PDmax	1W/A	Operation in ambient temperatures exceeding 40°C is possible if the power dissipation is limited either by reducing the steady-state current or by reducing the duty-cycle of the soft starter as shown in the table. Max.cycle time 15min.						
Power dissipation for intermittent operation PD	1W/A x dutycycle							
Cooling method	Natural convection							
Mounting	Vertical +/-30°							
Operating temperature range EN 60947-4-2	-5C° to 40°C							
Max. operating temperature with current derating	60°C							
Storage temperature EN 60947-4-2	-20C° to 80°C	<table border="1"> <thead> <tr> <th>By 40°C (STL X XX25)</th> <th>By 50°C (STL X XX25)</th> <th>By 60°C (STL X XX25)</th> </tr> </thead> <tbody> <tr> <td>100% load Duty-cycle 100%</td> <td>80% load Duty-cycle max. 0,8</td> <td>70% load Duty-cycle max. 0,65</td> </tr> </tbody> </table>	By 40°C (STL X XX25)	By 50°C (STL X XX25)	By 60°C (STL X XX25)	100% load Duty-cycle 100%	80% load Duty-cycle max. 0,8	70% load Duty-cycle max. 0,65
By 40°C (STL X XX25)	By 50°C (STL X XX25)	By 60°C (STL X XX25)						
100% load Duty-cycle 100%	80% load Duty-cycle max. 0,8	70% load Duty-cycle max. 0,65						

Environment

Degree of protection	IP 20	Pollution degree	3
----------------------	-------	------------------	---

Approval

cUL Std No. 508 Not approved STL 3 6925	
*UL: Use thermal overload protection as required by the National Electric Code. When protected by a non-time delay K5 or H Class fuse, rated 266% of motor FLA, this device is rated for use on a circuit capable of delivering not more than 5,000 rms. symmetrical amperes, 600 V maximum. Maximum surrounding temperature 40°C.	

Mounting and cable wiring information

Mounting information see page 44 / Cable wiring see page 45

Dimensions (se also page 36)

Type	H	D	W
45 mm module	94 mm	128.1 mm	45 mm

EMC

This component meets the requirements of the product standard EN60947-4-2 and is CE marked according to this standard. These products has been designed for class A equipment. Use of the product in domestic environments may cause radio interference, in which case the user may be required to employ additional mitigation methods.

* NOT cUL APPROVED

Starting Torque Limiter (STL Soft Starter for 1&3-phase motors, one controlled phase)

Wiring specifications

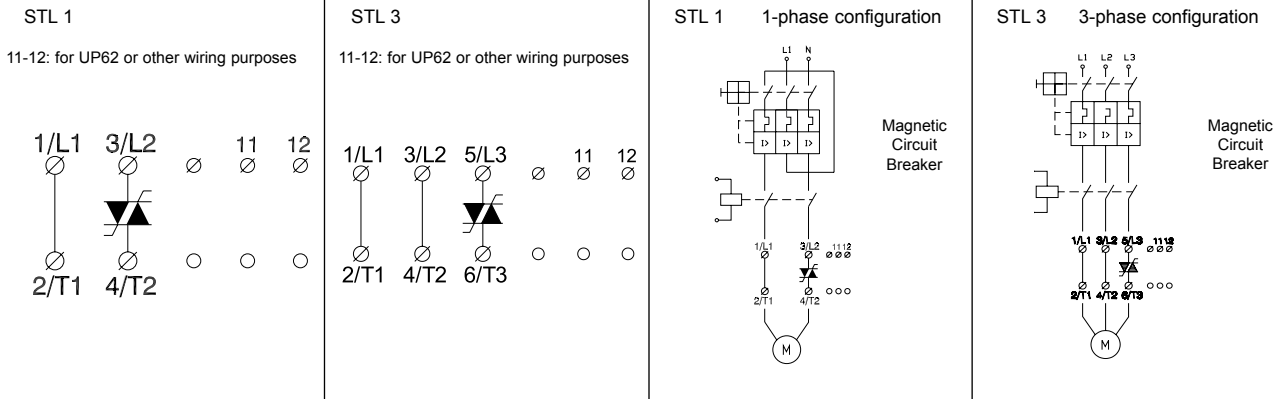

How to adjust ramp times and initial torque

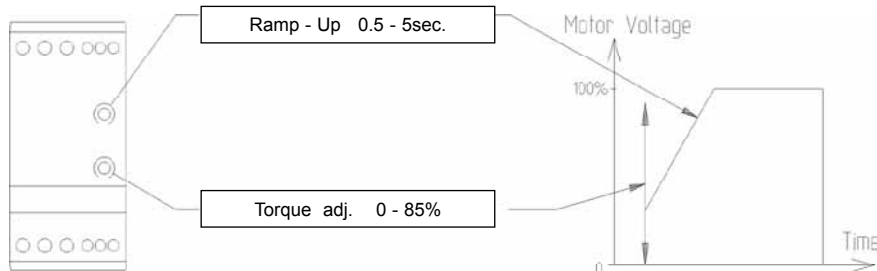

A. Ramp-Up time and initial torque (standard load) Use screwdriver 2 mm x 0.5 mm for adjustment

- 1) Set the *Ramp-Up* switch to maximum
- 2) Decrease the *Ram-Up* time until desired start is achieved
- 3) Set the *Initial Torque* switch to minimum
- 4) Switch the contactor ON for a short time. If the load does not rotate immediately increment the *Initial Torque* and try again. Repeat until the load starts to rotate immediately on start-up

NOTE:

- a) Control of the motor torque is achieved by acting on the motor voltage. The motor speed depends on the torque produced by the motor and the load on the motor shaft.
- b) A motor with little or no load will reach full speed before the voltage has reached its maximum value.
- c) Repeated starts may trip the motor protection relay.

Short-circuit protection by circuit breaker or fuses

Two type of short-circuit protection can be used:

- a) Short-circuit protection by circuit breaker.
- b) Short-circuit protection by fuses.

Short-circuit protection is divided into 2 levels Type 1 or Type 2

Co-ordination Type 1: Short-circuit protects the installation

Co-ordination Type 2: Short-circuit protects the installation and the semiconductor inside the motor controller

a) Short-circuit protection

Co-ordination type 1 will be obtained when using magnetic circuit breakers or standard gI/GI fuses.

Co-ordination type 2 will be obtained when using semiconductor fuses. When using semiconductor fuses the SCR will not be damaged due to transients and short circuits. The table indicates suitable fuses for co-ordination type 2 protection.

b) Short-circuit protection by fuses

Type 1: STL 1/3 XX15	Protection max. 50 A gL/gG
Type 1: STL 1/3 XX25	Protection max. 80 A gL/gG 63A T

Type 2: STL 1/3 XX15	Protection max. i^2t of the fuse 1800 A ² S
Type 2: STL 1/3 XX25	Protection max. i^2t of the fuse 6300 A ² S

Fuses from e.g. Ferraz, Siba, Bussmann can be used as short-circuit protection Type 2

More information concerning Co-ordination Type 2 see page 45

Start of single phase motor (application example)

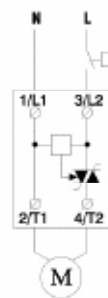

- By start S shall be switched On
- The STL starts to Ramp-Up the motorvoltage
- When the motor has to stop, S shall be switched off
- The STL 1 is now ready for a new start
- The STL 1 is applicable for standard single phase motors, capacitive motors, transformers etc.

Thermal overload protection (see also page 44)

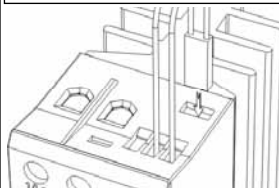

Optional thermal overload protection is possible by inserting a thermostat in a slot on the right hand side of the soft starter. Type number UP62

Soft Starter with Dynamic Brake (SMBC 3 two controlled phases)



- Rated operational voltage up to 480VAC 50/60Hz
- Rated operational current 1-25A
- Output signal for By-Pass and control of mechanical brake
- Ramp Up time and initial torque adjustable with kick start
- Adjustable Brake current
- Automatic stop detection
- Fast action brake mode with automatic motor field reduction
- Meets EN 60947-4-2 requirements

Item selection and technical specifications (see also motor table at page 11)

Load ratings	Item number by 208-240VAC 50/60Hz Line Voltage	Item number by 400-480VAC 50/60Hz Line Voltage		Ramp-Up / Brake-adjustment	Torque adjustment	Module-width
25A AC-53a	SMBC 3 DA 2325	SMBC 3 DA 4025		Ramp-up time 0.5 - 10 sec.	0- 85% adjustable of nominal torque with selectable kick start 200ms (break loose function)	90mm
27A AC-53b w. by-pass		SMBC 3 DA 4025		Brake current 0-50ADC.		90mm

Load specified with utilisation category AC-53a

SMBC 3 DA XX25 AC-53a: No by-pass contactors is necessary during running

Load specified with utilisation category AC53b

SMBC 3 DA 4025 AC-53b: By-pass contactor shall be used for bypassing the soft starter during running of the motor by 27A/15kW 400V load

Output load specification

SMBC 3 DA XX25 (without by-pass contactor)	More info. page 45	SMBC 3 DA XX25 (with by-pass contactor)	More info. page 45
Overload current profile AC-53a	X-Tx:8-3 : 100-3000	Overload current profile AC-53b	X-Tx:5-5 : 30
Overload relay trip class AC-53a	10 or 10A	Overload relay trip class AC-53b	10 or 10A
Leakage current	5mA ACmax.	Min. operational current	1A

Control terminal specifications

Control voltage by line voltage 208-240VAC A1-A2	24 - 230 VAC/DC
Control voltage by line voltage 400-480VAC A1-A2	24 - 480 VAC/DC
Pick-up voltage max.	20.4 VAC/DC
Drop-out voltage min.	5 VAC/DC
Max. control current for no operation	1mA
Response time max.	100msec.
Control current / power max.	15mA / 2VA

AC Auxiliary contacts

Output specifications for SMBC 3 DA XXXX BP

Terminal: 13-14, AC SCR output for start/stop function,
Terminal: 23-24, AC SCR output for connection of by-pass contactor.

Output specifications: SCR: 0.5A AC-14, AC15 24-230/480V 50-60Hz
Fusing:gl/gG Max i^2t 72A²S

Terminal: 11-12, have no connection with the internal circuit. Can be used in conjunction with a thermal overload protection or for other wiring purposes. See under general technical information.

Thermal specification

Power dissipation for continuous operation PDmax	2W/A without BP	Operation in ambient temperatures exceeding 40°C is possible if the power dissipation is limited either by reducing the steady-state current or by reducing the duty-cycle of the soft starter as shown in the table. Max.cycle time 15min.		
Power dissipation with semiconductor by-passed	4 W Max.			
Cooling method	Natural convection			
Mounting	Vertical +/-30°			
Operating temperature range EN 60947-4-2	-5°C to 40°C			
Max. operating temperature with current derating	60°C			
Storage temperature EN 60947-4-2	-20°C to 80°C			
		By 40°C	By 50°C	By 60°C
		100% load Duty-cycle 100%	80% load Duty-cycle max. 0.8	70% load Duty-cycle max. 0.65

Insulation specifications

Rated insulation voltage	Ui 660 Volt
Rated impulse withstand voltage	Uimp. 4 kVolt
Installation category	III

Environment

Degree of protection	IP 20	Pollution degree	3
----------------------	-------	------------------	---

Approval

cUL Std No. 508

UL:Use thermal overload protection as required by the National Electric Code. When protected by a non-time delay K5 or H Class fuse, rated 266% of motor FLA, this device is rated for use on a circuit capable of delivering not more than 5,000 rms. symmetrical amperes, 600 V maximum. Maximum surrounding temperature 40°C.

EMC

This component meets the requirements of the product standard EN60947-4-2 and is CE marked according to this standard. This products has been designed for class A equipment. Use of the product in domestic environments may cause radio interference, in which case the user may be required to employ additional mitigation methods.

Soft Starter with Dynamic Brake (SMBC 3 two controlled phases)

Wiring diagram

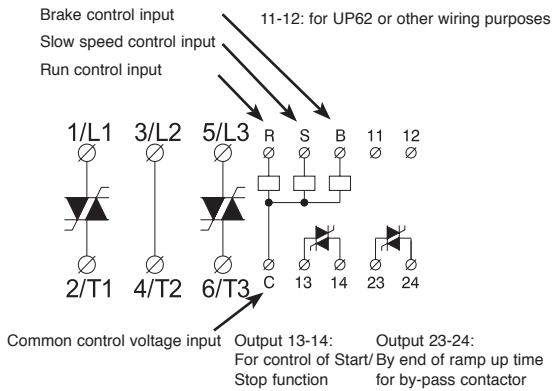

Wiring example: automatic brake to stop function

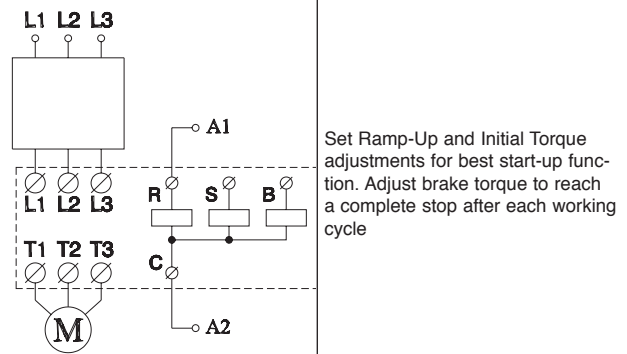

Set Ramp-Up and Initial Torque adjustments for best start-up function. Adjust brake torque to reach a complete stop after each working cycle

Wiring example: DC brake current configuration

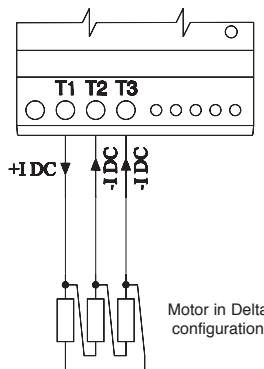

To achieve maximum brake torque the DC current is applied on all 3 motor windings. Direction of current is from T1 to T2 and T3.

Do not open any switches in the DC current path during the braking cycle as this might cause severe burning of the contacts.

Wiring example: Timer controlled brake cycle

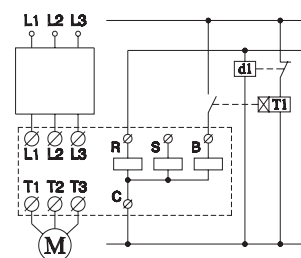

If the application only can accept a low braking torque below the sensing range of the stop detection it is possible to connect an external "delay on" operate timer to the Brake control input.

Functional description:
When control relay d1 and Run input is switched off timer T1 will activate the Brake input for the adjusted time.

Adjusting the brake current (connexion between brake torque, setting, brakecurrent and braketime)

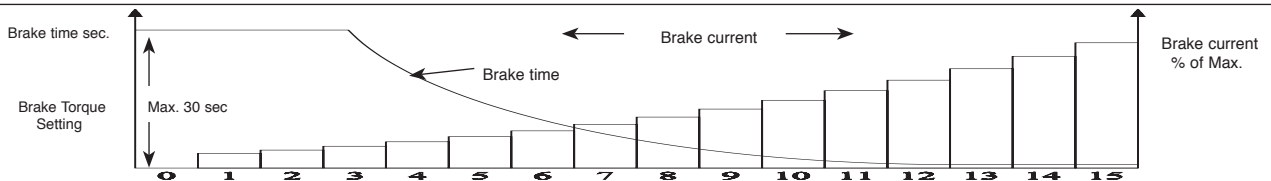

When the Brake current is set it is actually a DC voltage that is adjusted. The current is therefore depending on the ohmic resistance of the windings and the actual connection of the motor (Delta).

For small motors a high DC voltage is necessary and for bigger motors a low voltage can produce sufficient brake current. Therefore the brake current must be adjusted for the actual application.

Before start-up of an unknown application set the Brake Torque adjustment to 1. Increase until the desired stop time is achieved.

If it is impossible to reach a time long enough for the application an external timer must be connected. See also application information next page.

Automatic stop detection

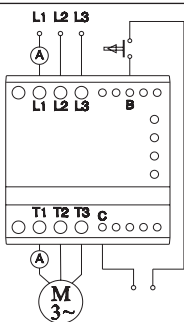

The motor speed is detected by sensing the DC brake current. As this controller can operate a wide range of motors with different wiring configurations, the ohmic resistance of the actual motor has a wide range, it is therefore necessary to adjust the "Brake Torque" (DC Brake current) to achieve correct function in the actual application.

If the current is set to a low value the brake will be switched off before the motor has come to a complete stop. If the current is set too high, it will be out of the detection range and cannot be switched off before end of the build-in maximum time (30 sec.).

The LED's will flash to indicate failure condition. The mains must be switched off and reapplied to reset this condition

CAUTION ! For bigger motors the current can be adjusted to a value that will destroy the controller or open the circuit breaker or fuse.

Before start-up of an unknown application set the Brake Torque adjustment to 1. To measure the Brake current activate the Brake Control input.

The DC brake current can be measured on the out put of T1 only. The AC value of the Brake current can be measured in L1 or L2. The DC current is approx. 1,5 times the AC current.

Functional diagram

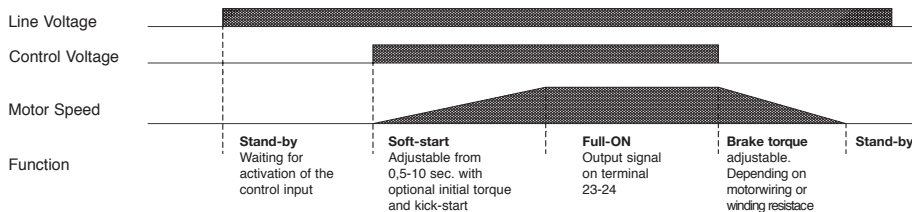

Basic application.

When the control voltage is applied the motor will soft-start. When the control voltage is switched off the automatic Brake cycle will operate. The application shall be overload- and shortcircuit protected by fuses or circuit breaker.

Application, adjustment hints and general specifications for SMBC 3

Short-circuit protection by circuit breaker or fuses

Two type of short-circuit protection can be used:

- Short-circuit protection by circuit breaker.
- Short-circuit protection by fuses.

Short-circuit protection is divided into 2 levels **Type 1** or **Type 2**

Co-ordination Type 1: Short-circuit protects the installation

Co-ordination Type 2: Short-circuit protects the installation and the semiconductor inside the motor controller

a) Short-circuit protection

Co-ordination type 1 will be obtained when using magnetic circuit breakers or standard gI/GI fuses.

Co-ordination type 2 will be obtained when using semiconductor fuses. When using semiconductor fuses the SCR will not be damaged due to transients and short circuits. The table indicates suitable fuses for co-ordination type 2 protection.

a1) Short-circuit protection by circuit breaker (continued)

It is recommended to overload protect the soft starter by a manual motor starter which is insensitive to the unbalanced operation condition during braking operation. The motor is thus protected also during the brake cycle. The manual motor starter will also short-circuit protect the Controller if prospective short-circuit limits are observed (Co-ordination 2.)

NOTE: Due to the integral brake function the motor is overload protected during the brake cycle. The phase unbalance in this mode might trip an overload relay with high sensitivity to phase unbalance.

Danfoss CTI 25 is not sensitive to unbalanced loads.

b) Short-circuit protection by fuses

Type 1: SMBC 3 DA XX25
Type 2: SMBC 3 DA XX25

Protection max. 80 A gL/gG 63A T
Protection max. i^2t of the fuse 6300 A²S

Fuses from e.g. Ferraz, Siba, Bussmann can be used as short-circuit protection Type 2

More information concerning Co-ordination Type 2 see page 45

Wiring example (Start/Stop with or without By-pass contactor)

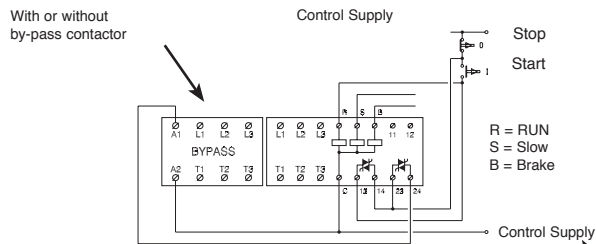

Motor wiring with or without by-pass

Standard wiring of a softstarter to a 3-phase motor in delta configuration.

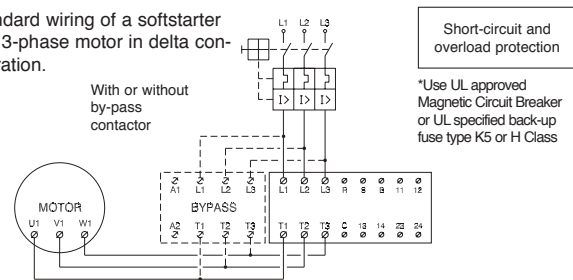

Functional diagram of start-stop/control/by-pass contactor

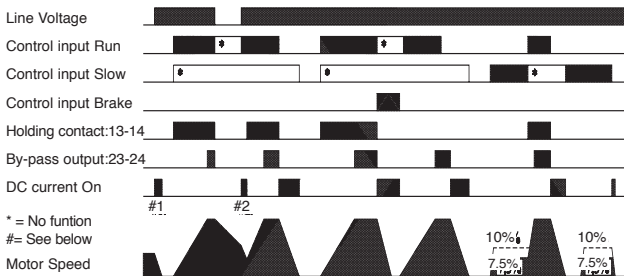

Setting of the operation mode selector

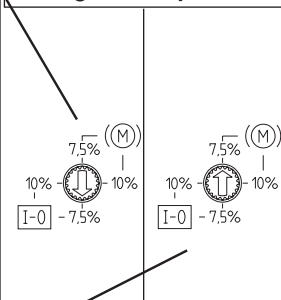

NOTE:

When terminal 13-14 is used as Start/Stop function, and 23-24 is used for by-pass: **Set the selector in position I-0** (7.5% or 10% if slow speed is used)

When terminal 13-14 & 23-24 is used as brake control: **Set the selector in position M** (7.5% or 10% if slow speed is used)

Control of mechanical brake and by-pass contactor

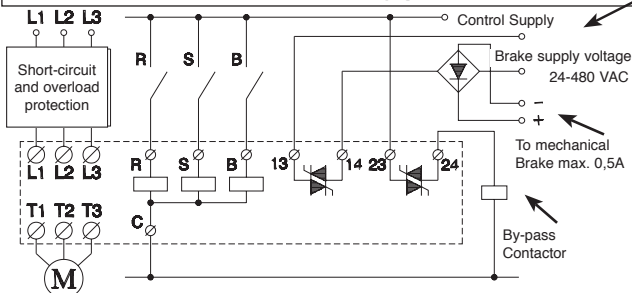

Thermal overload protection (see also page 44)

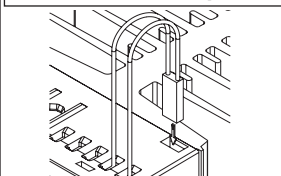

Optional thermal overload protection is possible by inserting a thermostat in a slot on the right hand side of the soft starter. Type number UP62

Functional diagram of mechanical brake/by-pass contact.

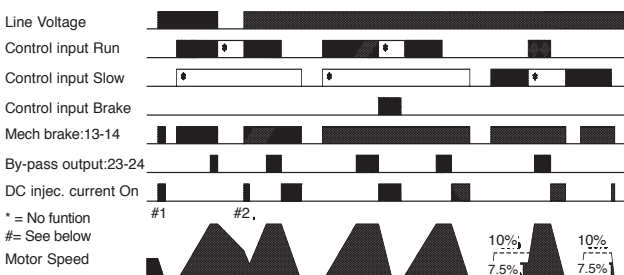

Note: #1. If the motor is running when the soft starter is switched On, the Auto Brake mode will stop the rotation.
Note: #2. With "RUN" signal present on Power-Up the soft starter will start the motor.

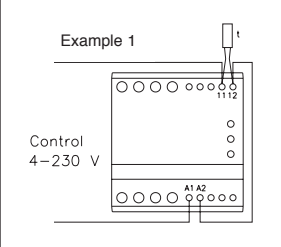

The thermostat can be connected in series with the control circuit of the soft starter. When the temperature of the heatsink exceeds 90°C the soft starter will switch Off.
Note: When the temperature has dropped approx. 30°C the soft starter will automatically be switched on again.

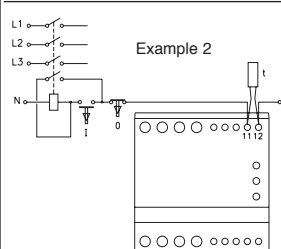

The thermostat is connected in series with the control circuit of the main contactor. When the temperature of the heatsink exceeds 90°C the main contactor will switch Off.
Note: A manual reset is necessary to restart this circuit.

Application, adjustment hints and general specifications for SMBC 3

How to adjust ramp time, initial torque and brake torque

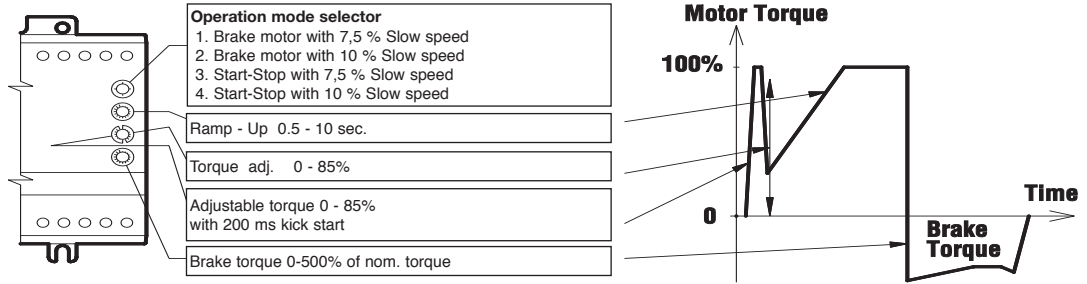

A. Standard load with automatic brake cycle

- A1) Set the *Ramp-Up* switch to maximum.
- A2) Set the *Brake Torque* switch to 1
- A3) Set the *Initial Torque* switch to minimum.
- A4) Apply control signal for a few seconds. If the load does not rotate immediately increment the *Initial Torque* and try again. Repeat until the load starts to rotate immediately on start-up.
- A5) Adjust *Ramp-Up* time to the desired starting time (scale is in seconds) is obtained.
- A6) Adjust *Brake Torque* until the desired stop time is obtained
 Note. If the current is set too high, the zero speed detect will not function. If the current is set too low, the zero speed detect will not function. To achieve a longer braking time an external timer must be installed as shown in application example page 15

B. High inertia loads with stiction

- If it is not possible to reach a smooth start for an application it might be it may be necessary to kick-start / Break loose function.
- B1) Set the *Ramp-Up* switch to maximum.
- B2) Set the *Brake-Torque* switch to 1.
- B3) Set the *Initial Torque* switch to minimum in the *Kick-start* mode.
- B4) Apply control signal for a few sec. If the motor stops right after the 200 ms "kick" increment the *initial torque* and try again. Repeat until the load continues to rotate after the "kick".
- B5) Adjust *Ramp-Up* time to the desired start time (the scale is in seconds) and start the motor.
- B6) Adjust *Brake Torque* until the desired stop time is obtained

LED information:

Note: When both LED's are flashing, no connection to the motor

Please note:

- The Soft Starter will read time and torque settings in stand by mode i.e. after the Brake cycle. Repeated starts may trip the motor protection relay.
- Make sure NOT to set the rotary switches in between positions as this corrupts the time and torque adjustment. Use screwdriver 2 mm x 0.5 mm
- Caution: Set the Brake Torque switch to 1, before switching the controller ON

CAUTION!

For bigger motors the Brake Torque can be adjusted to a value that will destroy the controller or open the circuit breaker or fuse. Only increase Brake Torque in single steps for an unknown application.

LED status indication

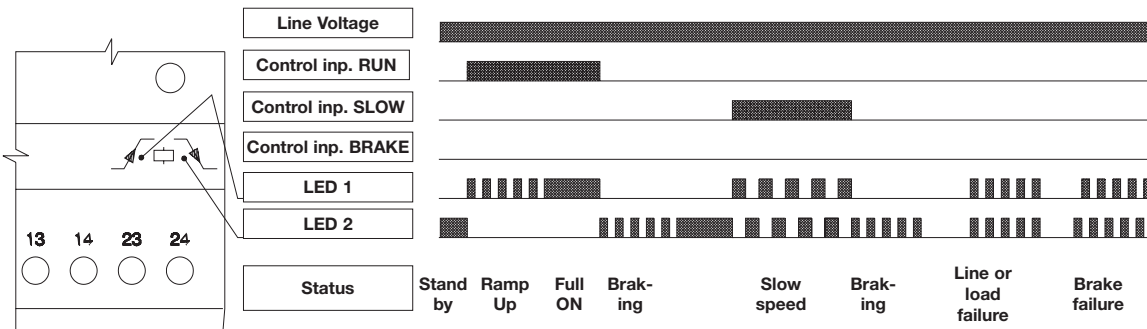

Slow speed-operation (functional diagram)

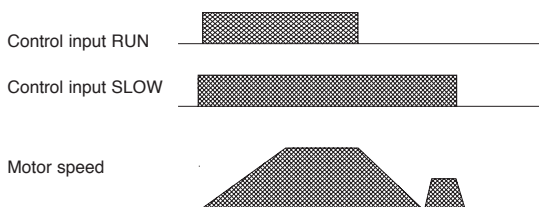

The Slow speed option is intended for short time operation in applications where an exact positioning is needed, for example cranes. The motor operates at full speed until the application reaches the early limit switch, where the motor is braked until stop is detected, then it will continue until final position and brake down to stop in the exact position. There is 2 selectable speeds 7,5 % and 10 % of nominal speed. **NB. Torque levels are lower than nominal torque.** In slow speed 7,5 % mode the operational current in L2 is approx. 2.5 times the nominal current. In slow speed 10 % mode the operational current in L2 is approx. 2 times the nominal current but with lower torque.
 Note: RUN input signal has priority over SLOW input signal. If Brake Torque is adjusted to "0" Slow speed will be ignored.

Mounting and cable wiring information

Mounting information see page 44 / Cable wiring see page 45

Dimensions (see also page 44)

Type	H	D	W
90 mm module	94 mm	128.1 mm	90 mm

3-Phase electronic reversing contactor (SRC)



- Rated operational voltage up to 480 VAC 50/60Hz
- Rated operational current up to 10A AC-53
- Two separate control inputs with mutual interlock
- Control voltage from 5-24VDC or 24-230VAC/DC
- LED Status indication
- Meets EN 60947-4-2 requirements
- Requires only 45 mm DIN rail space

Item selection and technical specifications

Load ratings AC-53 motor load stand. AC-4 motor load inching / plugging	Control voltage		Item number by 24-480VAC 50/60Hz Line Voltage		Module-width
10A AC-53 / 8A AC-4	5-24 VDC		SRC 3 DD 4010		45mm
10A AC-53 / 8A AC-4	24-230 VAC/DC		SRC 3 DA 4010		45mm

Output load specification

Operational current AC-53	10A	Leakage current	5mA ACmax.
Operational current AC-4	8A	Min. operational current	50mA
Duty cycle	100%		

Control terminal specifications

SRC 3 DD 4010		SRC 3 DA 4010	
Control voltage	5 - 24 VDC	Control voltage	24- 230 VAC/DC
Pick-up voltage max.	4.25 VDC	Pick-up voltage max.	20.4 VAC/DC
Drop-out voltage min.	1.5 VDC	Drop-out voltage min.	7.2 VAC/DC
Control current	25mA @ 4VDC	Control current / power max.	6mA / 1.5VA@24VDC
Response time max.	1/2 cycle	Response time max.	1cycle
Interlock time max.	80 msec.	Interlock time max.	150 msec.

Thermal specification

Power dissipation for continuous operation PDmax	2.2 W/A	Operation in ambient temperatures exceeding 40°C is possible if the power dissipation is limited either by reducing the steady-state current or by reducing the duty-cycle of the contactor as shown in the table. Max.cycle time 15min.		
Power dissipation for intermittent operation PD	2.2 W/A x dutycycle			
Cooling method	Natural convection			
Mounting	Vertical +/-30°			
Operating temperature range EN 60947-4-2	-5°C to 40°C			
Max. operating temperature with current derating	60°C			
Storage temperature EN 60947-4-2	-20°C to 80°C			
		By 40°C	By 50°C	By 60°C
		100% load Duty-cycle 100%	80% load Duty-cycle max. 0.8	70% load Duty-cycle max. 0.65
Environment				
Degree of protection	IP 20	Pollution degree	3	

Insulation specifications

Rated insulation voltage	Ui 660 Volt	*UL:Use thermal overload protection as required by the National Electric Code. When protected by a non-time delay K5 or H Class fuse, rated 266% of motor FLA, this device is rated for use on a circuit capable of delivering not more than 5,000 rms. symmetrical amperes, 600 V maximum. Maximum surrounding temperature 40°C.
Rated impulse withstand voltage	Uimp. 4 kVolt	
Installation category	III	

Functional diagram

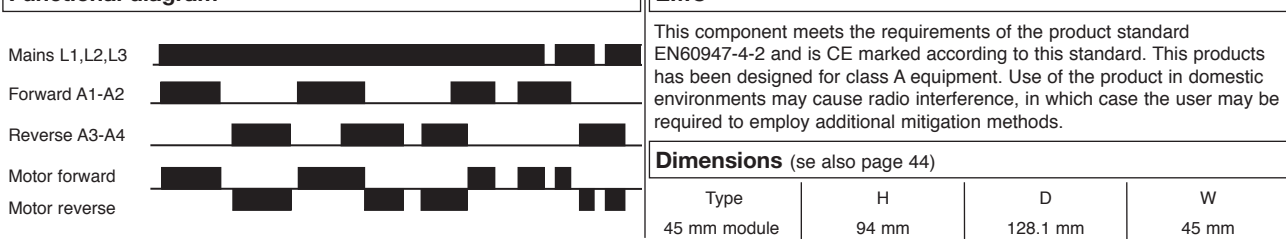

3-Phase electronic reversing contactor (SRC)

Wiring specifications

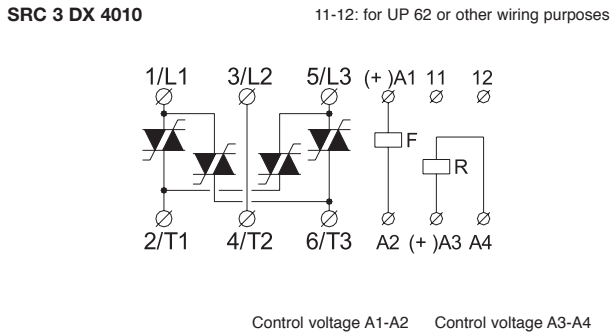

Combining Reversing Electronic Contactor & Soft Starter

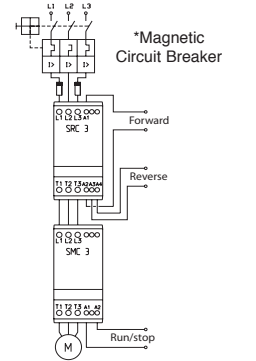

Soft-reversing of motors up to 10A
 A Soft-Reversing of a motor can easily be achieved by connecting a reversing relay to the Soft Starter. The reversing relay type SRC 3 DX will determine the direction of rotation Forward or Reverse and the Soft Starter type SMC 3/32/33 will perform soft-starting and soft-stopping of the motor. If soft-stop is not required the application can be simplified by connecting the control circuit of the Soft Starter to the main terminals as shown under Line Controlled Soft-Start. A delay of approx. 0.5 sec. between forward and reverse control signal must be allowed to avoid influence from the voltage generated by the motor during turn Off.

Short-circuit protection by circuit breaker or fuses

Two type of short-circuit protection can be used:
 a) Short-circuit protection by circuit breaker.
 b) Short-circuit protection by fuses.

Short-circuit protection is divided into 2 levels **Type 1** or **Type 2**

Co-ordination Type 1: Short-circuit protects the installation

Co-ordination Type 2: Short-circuit protects the installation and the semi-conductors inside the motor controller

a) Short-circuit protection
 Co-ordination type 1 will be obtained when using magnetic circuit breakers or standard gI/GI fuses.
 Co-ordination type 2 will be obtained when using semiconductor fuses. When using semiconductor fuses the SCR will not be damaged due to transients and short circuits. The table indicates suitable fuses for co-ordination type 2 protection.

b) Short-circuit protection by fuses

Type 1: SRC 3 DX 4010	Protection max. 50 A gL/gG
Type 2: SRC 3 DX 4010	Protection max. i^2t of the fuse 610 A ² S

Fuses from e.g. Ferraz, Siba, Bussmann can be used as short-circuit protection Type 2
 More information concerning Co-ordination Type 2 see page 45

Overload Protection in Motor Control Reversing

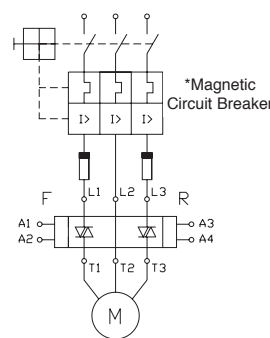

Overload protection of the motor is easily achieved by installing a manual thermal magnetic circuit breaker on the supply side of the motor. The circuit breaker provides means for padlocking and the necessary clearance for use as a circuit isolator according to EN 60204-1.

Adjust the current limit on the MCB according to the rated nominal current of the motor
 *Use UL approved Magnetic Circuit Breaker or UL specified back-up fuse type K5 or H Class

Thermal overload protection (see also page 44)

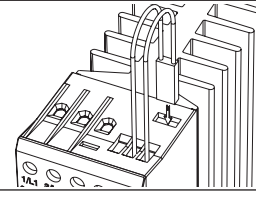

Optional thermal overload protection is possible by inserting a thermostat in a slot on the right hand side of the contactor. Type number UP62

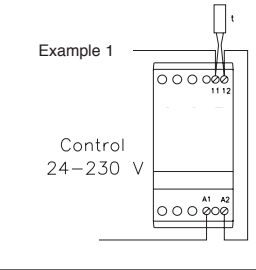

The thermostat can be connected in series with the control circuit of the contactor.
 When the temperature of the heatsink exceeds 90°C the soft starter will switch Off.
Note: When the temperature has dropped approx. 30°C the contactor will automatically be switched on again.

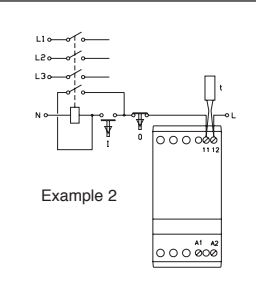

The thermostat is connected in series with the control circuit of the main contactor.
 When the temperature of the heatsink exceeds 90°C the main contactor will switch Off.
Note: A manual reset is necessary to restart this circuit.

Utilisation Categories EN60947-4-2

Category AC-53: Starting, switching off motors during running
Category AC-4: Starting, plugging, reversing the motors rapidly while the motor is during.

Mounting and cable wiring information

Mounting information see page 44 / Cable wiring see page 45

3-Phase electronic motor contactor (SMC 3 DOL Direct On Line)



- For Direct On Line start of 3 phase motors
- Rated operational voltage up to 600 VAC 50/60 Hz
- Rated operational current up to 15A AC-53
- Control voltage: 24-60VDC / 24-480VAC
- High number of start/stop operations / hour
- LED Status indication
- Meets EN 60947-4-2 requirements
- Requires only 45 mm DIN rail space

Item selection and technical specifications

Load ratings AC-53 motor load stand. AC-4 motor load inching / plugging	Control voltage	Item number by 208-240VAC 50/60Hz Line Voltage	Item number by 400-480VAC 50/60Hz Line Voltage	Item number by 550-600VAC 50/60Hz Line Voltage	Module-width
15A AC-53	24-60VDC / 24-480VAC	SMC 3 DA 2315 DOL	SMC 3 DA 4015 DOL	SMC 3 DA 6015 DOL	45mm

Output load specification

Operational current AC-53	15A	Min. operational current	50mA
Leakage current	5mA ACmax.	Duty cycle	100%

Control terminal specifications

Control voltage	24-60 VDC/24-480 VAC	Control current / power max.	6mA / 1.5 VA
Pick-up voltage max.	20.4 VAC / DC	Max. control voltage	510 VAC
Drop-out voltage min.	5 VAC / DC	Response time max.	1 cycle

Thermal specification

Power dissipation for continuous operation PDmax	2.2 W/A	Operation in ambient temperatures exceeding 40°C is possible if the power dissipation is limited either by reducing the steady-state current or by reducing the duty-cycle of the soft starter as shown in the table.	
Power dissipation for intermittent operation PD	2.2 W/A x dutycycle		
Cooling method	Natural convection		
Mounting	Vertical +/-30°		
Operating temperature range EN 60947-4-2	-5°C to 40°C		
Max. operating temperature with current derating	60°C		
Storage temperature EN 60947-4-2	-20°C to 80°C		
		By 40°C	By 50°C
		100% load Duty-cycle 100%	80% load Duty-cycle max. 0.8
			By 60°C
			70% load Duty-cycle max. 0.65

Insulation specifications

Rated insulation voltage	Ui 660 Volt
Rated impulse withstand voltage	Uimp. 4 kVolt
Installation category	III

Utilisation Categories EN60947-4-2

Category AC - 53	Starting, switching off motors during running.
Category AC - 4	Starting, plugging, reversing the motor rapidly while the motor is running.
Category AC - 52a	Control of slipping motor stators
Category AC - 53a	Control of squirrel cage motor
Category AC - 58a	Control of hermetic refrigerant compressors with automatic resetting of overload releases

EMC

This component meets the requirements of the product standard EN60947-4-2 and is CE marked according to this standard. This products has been designed for class A equipment. Use of the product in domestic environments may cause radio interference, in which case the user may be required to employ additional mitigation methods.

Mounting and cable wiring information

Mounting information see page 44 / Cable wiring see page 45

Dimensions (se also page 44)

Type	H	D	W
45 mm module	94 mm	128.1 mm	45 mm

3-Phase electronic motor contactor (SMC 3 DOL Direct On Line)

Wiring specifications

SMC 3 DA XX15 DOL

11-12: For UP62 or other wiring purposes

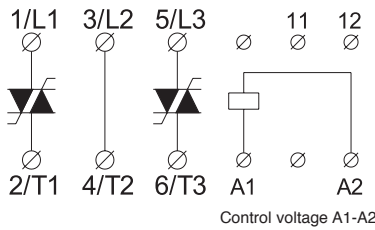

Short-circuit protection by circuit breaker or fuses

Two type of short-circuit protection can be used:

- Short-circuit protection by circuit breaker.
- Short-circuit protection by fuses.

Short-circuit protection is divided into 2 levels **Type 1 or Type 2**

Co-ordination Type 1: Short-circuit protects the installation

Co-ordination Type 2: Short-circuit protects the installation and the semiconductor inside the motor controller

a) Short-circuit protection

Co-ordination type 1 will be obtained when using magnetic circuit breakers or standard gI/GI fuses.

Co-ordination type 2 will be obtained when using semiconductor fuses. When using semiconductor fuses the SCR will not be damaged due to transients and short circuits. The table indicates suitable fuses for co-ordination type 2 protection.

b) Short-circuit protection by fuses

Type 1: SMC 3 DA XX15 DOL Protection max. 50 A gL/gG

Type 2: SMC 3 DA XX15 DOL Protection max. i^2t of the fuse 1800 A²s

Fuses from e.g. Ferraz, Siba, Bussmann can be used as short-circuit protection Type 2

More information concerning Co-ordination Type 2 see page 45

Overload Protection in Motor Control Reversing

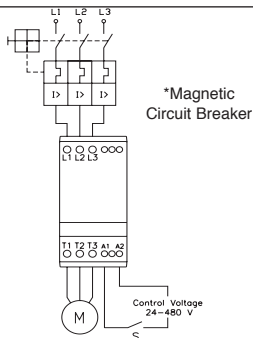

Overload protection of the motor is easily achieved by installing a manual thermal magnetic circuit breaker on the supply side of the motor.

The circuit breaker provides means for padlocking and the necessary clearance for use as a circuit isolator according to EN 60204-1.

Adjust the current limit on the MCB according to the rated nominal current of the motor

*Use UL approved Magnetic Circuit Breaker or UL specified back-up fuse type K5 or H Class

Thermal overload protection (see also page 44)

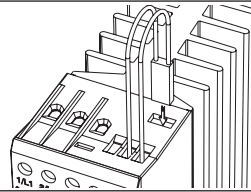

Optional thermal overload protection is possible by inserting a thermostat in a slot on the right hand side of the soft starter. Type number UP62

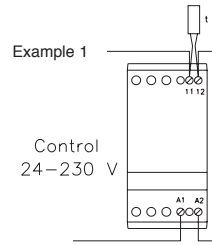

The thermostat can be connected in series with the control circuit of the soft starter. When the temperature of the heatsink exceeds 90°C the soft starter will switch Off.

Note:

When the temperature has dropped approx. 30°C the soft starter will automatically be switched on again.

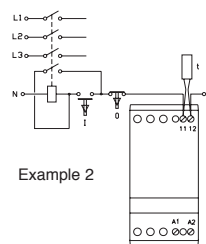

The thermostat is connected in series with the control circuit of the main contactor.

When the temperature of the heatsink exceeds 90°C the main contactor will switch Off.

Note:

A manual reset is necessary to restart this circuit.

SMC 3 DOL General application information

The SMC 3 DOL has been developed for cranes and other harsh applications where inching, jogging and plugging is frequently used and where a high number of operating cycles are essential. In such applications the lifetime of the equipment is normally limited by the short lifetime of the electromechanical contactor. Electromechanical contactors are not designed to switch off motors in locked rotor- or overload conditions where the current is 6 times the nominal operational current (AC-4). The severe arcing will burn the contact elements resulting in unreliable contact function. The Semiconductor Contactor will close the contacts in the zero crossing of the mains voltage and switch-Off will always occur in the zero crossing of the motor current in this way voltage kickback from the inductive motor windings is avoided. The lifetime, therefore, of the Semiconductor Contactor will always be at least one decade longer than the electromechanical contactor.

Comparison of lifetime in different utilization categories

Utilization-categories	Typical applications	Electro-mechanical Contactor	Semiconductor Contactors SMC3DA...DOL
AC-52a	Control of slip-ring motors, starting, switching Off	0.7 Mill. Cycles	25 Mill. Cycles
AC-53a	Control of squirrel-cage motors, starting, switching Off	1.3 Mill. Cycles	25 Mill. Cycles
AC-4	Control of squirrel-cage motors, starting, plugging, inching	0.06 Mill. Cycles	5 Mill. Cycles

1 Phase electronic contactor (SC 1)



- Rated operational voltage up to 690VAC 50/60 Hz
- Rated operational current up to 15/30A/50/63A AC-1
- Control voltage from 5-24 VDC or 24-230 VAC/DC
- Compact modular design 22.5, 45, or 90 mm
- LED Status indication
- Meets EN 60947-4-3 requirements
- Requires no additional components
- Built-in varistor protection
- IP-20 Protection

Item selection and technical specifications

Load AC-1/51 Heating - element	Load AC-3 Motor	Load AC-55b Lamp	Load AC-56a Transformer	Control voltage	Item number by 12-240VAC 50/60Hz Line Voltage	Item number by 24-480VAC 50/60Hz Line Voltage	Item number by 24-600VAC 50/60Hz Line Voltage	Item number by 24-690VAC 50/60Hz Line Voltage	Modul-breite
15A	15A 10A by 600 VAC	15A	15A	5-24 VDC	SC 1 DD 2315	SC 1 DD 4015	SC 1 DD 6015-1*	SC 1 DD 6915*#	22.5mm
				24-230 VAC/DC	SC 1 DA 2315	SC 1 DA 4015	SC 1 DA 6015-1*	SC 1 DA 6915*#	22.5mm
30A	15A	20A	15A	5-24 VDC	SC 1 DD 2330	SC 1 DD 4030	SC 1 DD 6030	SC 1 DD 6930*#	45mm
				24-230 VAC/DC	SC 1 DA 2330	SC 1 DA 4030	SC 1 DA 6030	SC 1 DA 6930*#	45mm
50A	15A	20A	15A	5-24 VDC	SC 1 DD 2350	SC 1 DD 4050	SC 1 DD 6050	SC 1 DD 6950*#	90mm
				24-230 VAC/DC	SC 1 DA 2350	SC 1 DA 4050	SC 1 DA 6050	SC 1 DA 6950*#	90mm
63A	30A	40A	30A	5-24 VDC	SC 1 DD 2363 *	SC 1 DD 4063 *	SC 1 DD 6063 *	SC 1 DD 6963*#	90mm
				24-230 VAC/DC	SC 1 DA 2363 *	SC 1 DA 4063 *	SC 1 DA 6063 *	SC 1 DA 6963*#	90mm

Output load specification

Leakage current	1mA ACmax.	Min. operational current	10mA
Duty cycle	100%		

Control terminal specifications

SC 1 DD XXXX (DC)		SC 1 DA XXXX (AC/DC)	
Control voltage	5-24 VDC	Control voltage	24-230 VAC/DC
Pick-up voltage max.	4.25 VDC	Pick-up voltage max.	20.4 VAC/DC
Drop-out voltage min.	1.5 VDC	Drop-out voltage min.	7.2 VAC/DC
Control current voltage	15 mA@24 VDC	Control current / power max.	6 mA / 1.5VA@24 VDC
Max. control voltage	32 VDC	Max. control voltage	253 VAC/DC
Response time max.	1/2 cycle	Response time max.	1 cycle

Thermal specification

Power dissipation for continuous operation PDmax	1.2 W/A	Operation in ambient temperatures exceeding 40°C is possible if the power dissipation is limited either by reducing the steady-state current or by reducing the duty-cycle as shown in the table. Max.cycle time 15min.		
Power dissipation for intermittent operation PD	1.2 W/A x dutycycle			
Cooling method	Natural convection	By 40°C	By 50°C	By 60°C
Mounting	Vertical +/-30°	100% load Duty-cycle 100%	80% load Duty-cycle max. 0.8	70% load Duty-cycle max. 0.65
Operating temperature range EN 60947-4-3	-5°C to 40°C			
Max. operating temperature with current derating	60°C			
Storage temperature EN 60947-4-3	-20°C to 80°C			

Environment

Degree of protection	IP 20	Pollution degree	3
----------------------	-------	------------------	---

Approval

cUL Std No. 508. **Not approved SC1 DX 6015-1 + SC1 DX XX63 + SC1 DX 69XX**
 UL: Use thermal overload protection as required by the National Electric Code. When protected by a non-time delay K5 or H Class fuse, rated 266% of motor FLA, this device is rated for use on a circuit capable of delivering not more than 5,000 rms. symmetrical amperes, 600 V maximum. Maximum surrounding temperature 40°C.

Insulation specifications

Rated insulation voltage	Ui 660 Volt
Rated insulation voltage #	Ui 690 Volt
Rated impulse withstand voltage	Uimp. 4 kVolt
Installation category	III

* NOT cUL APPROVED

1 Phase electronic contactor (SC 1)

Wiring specifications

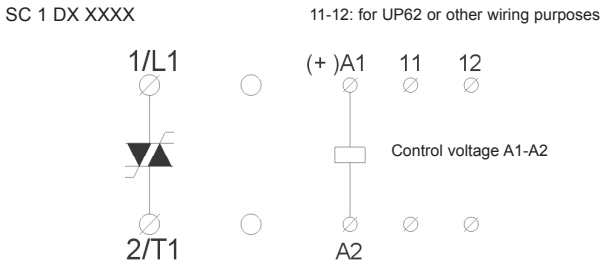

Short-circuit protection by fuses

Two type of short-circuit protection can be used:

Short-circuit protection by fuses

Fuse short-circuit protection is divided into 2 levels Type 1 or Type 2

Co-ordination Type 1: Short-circuit protects the installation

SC 1 DX XX15	Protection max. 50A gL/gG
SC 1 DX XX15-1	Protection max. 50A gL/gG
SC 1 DX XX30	Protection max. 50A gL/gG
SC 1 DX XX50	Protection max. 50A gL/gG
SC 1 DX XX63	Protection max. 80A gL/gG

Co-ordination Type 2: Short-circuit protects the installation and the semi conductors inside the motor controller

SC 1 DX XX15	Protection max. i^2t of the fuse	610 A ² S
SC 1 DX XX15-1	Protection max. i^2t of the fuse	610 A ² S
SC 1 DX XX30	Protection max. i^2t of the fuse	1800 A ² S
SC 1 DX 6930	Protection max. i^2t of the fuse	6300 A ² S
SC 1 DX XX50	Protection max. i^2t of the fuse	1800 A ² S
SC 1 DX 6950	Protection max. i^2t of the fuse	6300 A ² S
SC 1 DX XX63	Protection max. i^2t of the fuse	6300 A ² S

Fuses from e.g. Ferraz, Siba, Bussmann can be used as short-circuit protection Type 2

Short Circuit Protection with standard fuse for SC1DX..15

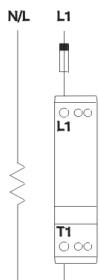

Short Circuit Protection for SC1 DX XX15 (15 A Type)
Co-ordination Type 2
Line Voltage up to 480 V. Due to the oversized Output SCR's the contactor is fully protected by a standard fuse up to 16 A. Operating Class gL/gG..

No need for Ultra Fast Fuses
Max Load at 230 V: 3.5 kW
Max Load at 400 V: 6.0 kW
Max Load at 480 V: 7.2 kW

EMC

This component meets the requirements of the product standard EN 60947-4-3 and is CE marked according to this standard. This products has been designed for class A equipment. Use of the product in domestic environments may cause radio interference, in which case the user may be required to employ additional mitigation methods.

Utilisation Categories (EN 60947-4-3)

AC - 51	Switching of resistive loads
AC - 55a	Switching of electric discharge lamp controls
AC - 55b	Switching of incandescent lamps
AC - 56a	Switching of transformers

Thermal overload protection (see also page 44)

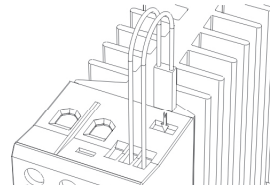

Optional thermal overload protection is possible by inserting a thermostat in a slot on the right hand side of the electronic contactor. Type number UP62

Example 1

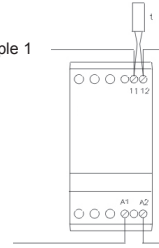

The thermostat can be connected in series with the control circuit of the electronic contactor. When the temperature of the heatsink exceeds 90°C the electronic contactor will switch Off.

Note:

When the temperature has dropped approx. 30°C the electronic contactor will automatically be switched on again.

Example 2

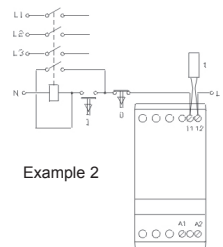

The thermostat is connected in series with the control circuit of the main contactor.

When the temperature of the heatsink exceeds 90°C the main contactor will switch Off.

Note:

A manual reset is necessary to restart this circuit.

Common Short Circuit Protection SC 1 DX XX15

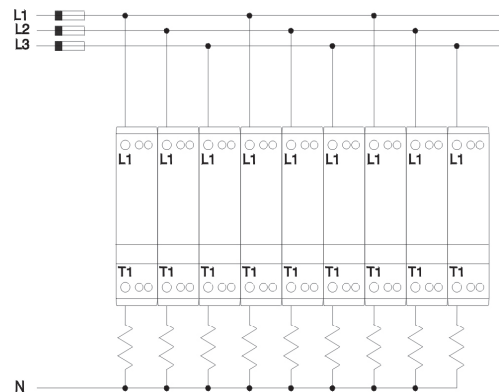

Short Circuit Protection for several Contactors e.g. SC1 DX XX15

Max Fuse 50 A gL/gG for Short Circuit
Coordination type 1

SC1 DX 2315 / SC 1 DX 4015
Max Fuse 1800 A²s
e.g. Siemens SILIZED 5SD4 60
Short Circuit Coordination type 2

SC1 DX 6015
Max Fuse 450 A²s
e.g. Siemens SILIZED 5SD4 50
Short Circuit Coordination type 2

Dimensions (see also page 44)

Type	H	D	W
22.5 mm module	94 mm	124.3 mm	22.5 mm
45 mm module	94 mm	124.3 mm	45 mm
90 mm module	94 mm	124.3 mm	90 mm

Mounting and cable wiring information

Mounting information see page 44 / Cable wiring see page 45

1 Phase electronic contactor (RC 11 Heatingelement)



- Rated operational voltage up to 480VAC 50/60 Hz
- Rated operational current up to 10/15/30/50/63A AC-1
- Control voltage from 5-24 VDC or 24-230 VAC/DC
- Compact modular design 22.5, 45 or 90 mm
- LED Status indication
- Meets EN 60947-4-3 requirements
- Requires no additional components
- Built-in varistor protection
- IP-20 Protection

Item selection and technical specifications

Load AC-1/51 Heating-element	Control voltage	Item number by 12-240VAC 50/60Hz Line Voltage	Load in kW by 230V	EAN Nr. 5705 609	Item number by 24-480VAC 50/60Hz Line Voltage	Load in kW by 400V	EAN Nr. 5705 609	Module-width
10A	5-24 VDC	RC 11 DD 2310	2.3 kW	002 152				W = 22.5mm
15A	5-24 VDC 24-230 VAC/DC	RC 11 DD 2315	Max. 3.5 kW	002169	RC 11 DD 4015	Max. 6.0 kW	002 206	W = 22.5mm
		RC 11 DA 2315		002 077	RC 11 DA 4015		002 114	W = 22.5mm
30A	5-24 VDC 24-230 VAC/DC	RC 11 DD 2330	Max. 6.9 kW	002 176	RC 11 DD 4030	Max. 12.0 kW	002 213	W = 45mm
		RC 11 DA 2330		002 084	RC 11 DA 4030		002 121	W = 45mm
50A	5-24 VDC 24-230 VAC/DC	RC 11 DD 2350	Max. 11.5 kW	002 183	RC 11 DD 4050	Max. 20.0 kW	002 220	W = 90mm
		RC 11 DA 2350		002 091	RC 11 DA 4050		002 138	W = 90mm
63A	5-24 VDC 24-230 VAC/DC	RC 11 DD 2363	Max. 14.5 kW	002 190	RC 11 DD 4063	Max. 25.2 kW	002 237	W = 90mm
		RC 11 DA 2363		002 107	RC 11 DA 4063		002 145	W = 90mm

Output load specification

Leakage current	1mA ACmax.	Min. operational current	10mA
Duty cycle	100%		

Control terminal specifications

RC 11 DD XXXX (DC)		RC 11 DA XXXX (AC/DC)	
Control voltage	5-24 VDC	Control voltage	24-230 VAC/DC
Pick-up voltage max.	4.25 VDC	Pick-up voltage max.	20.4 VAC/DC
Drop-out voltage min.	1.5 VDC	Drop-out voltage min.	7.2 VAC/DC
Control current voltage RC 11 DD 2310	8 mA@24 VDC	Control current / power max.	8 mA / 2.5VA@24 VDC
Control current voltage RC 11 DD XXXX	15 mA@24 VDC	Max. control voltage	253 VAC/DC
Max. control voltage	32 VDC	Response time max.	1 cycle
Response time max.	1/2 cycle		

Thermal specification

Power dissipation for continuous operation PDmax	1.2 W/A	Operation in ambient temperatures exceeding 40°C is possible if the power dissipation is limited either by reducing the steady-state current or by reducing the duty-cycle as shown in the table. Max.cycle time 15min.		
Power dissipation for intermittent operation PD	1.2 W/A x dutycycle			
Cooling method	Natural convection			
Mounting	Vertical +/-30°			
Operating temperature range EN 60947-4-3	-5°C to 40°C			
Max. operating temperature with current derating	60°C			
Storage temperature EN 60947-4-3	-20°C to 80°C			
		By 40°C	By 50°C	By 60°C
		100% load Duty-cycle 100%	80% load Duty-cycle max. 0.8	65% load Duty-cycle max. 0.65
Environment				3
Degree of protection		IP 20	Pollution degree	

Insulation specifications

Rated insulation voltage	Ui 660 Volt
Rated impulse withstand voltage	Uimp. 4 kVolt
Installation category	III

1 Phase electronic contactor (RC 11 Heatingelement)

Wiring specifications

RC 11 DX XXXX

11-12: for UP62 or other wiring purposes

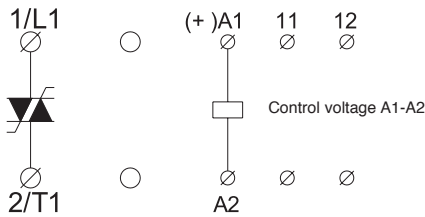

Short-circuit protection by fuses

Two type of short-circuit protection can be used:

Short-circuit protection by fuses

Fuse short-circuit protection is divided into 2 levels **Type 1** or **Type 2**

Co-ordination Type 1: Short-circuit protects the installation

RC 11 DX 2310	Protection max. 16A gL/gG
RC 11 DX XX15	Protection max. 50A gL/gG
RC 11 DX XX30	Protection max. 50A gL/gG
RC 11 DX XX50	Protection max. 50A gL/gG
RC 11 DX XX63	Protection max. 80A gL/gG

Co-ordination Type 2: Short-circuit protects the installation and the semi-conductors inside the motor controller

RC 11 DX 2310	Protection max. i^2t of the fuse	180 A ² S
RC 11 DX XX15	Protection max. i^2t of the fuse	610 A ² S
RC 11 DX XX30	Protection max. i^2t of the fuse	610 A ² S
RC 11 DX XX50	Protection max. i^2t of the fuse	1800 A ² S
RC 11 DX XX63	Protection max. i^2t of the fuse	6300 A ² S

Fuses from e.g. Ferraz, Siba, Bussmann can be used as short-circuit protection Type 2

More information concerning Co-ordination Type 2 see page 45

EMC

This component meets the requirements of the product standard EN 60947-4-3 and is CE marked according to this standard. This products has been designed for class A equipment. Use of the product in domestic environments may cause radio interference, in which case the user may be required to employ additional mitigation methods.

Utilisation Categories (EN 60947-4-3)

- AC - 51 Switching of resistive loads
- AC - 55a Switching of electric discharge lamp controls
- AC - 55b Switching of incandescent lamps
- AC - 56a Switching of transformers

Thermal overload protection (see also page 44)

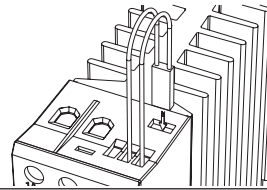

Optional thermal overload protection is possible by inserting a thermostat in a slot on the right hand side of the electronic contactor. Type number UP62

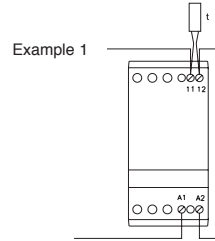

The thermostat can be connected in series with the control circuit of the electronic contactor. When the temperature of the heatsink exceeds 90°C the electronic contactor will switch Off.

Note:

When the temperature has dropped approx. 30°C the electronic contactor will automatically be switched on again.

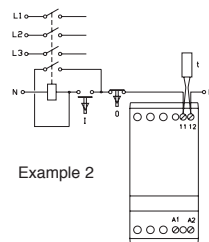

The thermostat is connected in series with the control circuit of the main contactor.

When the temperature of the heatsink exceeds 90°C the main contactor will switch Off.

Note:

A manual reset is necessary to restart this circuit.

Common Short Circuit Protection RC 11 DX XX15

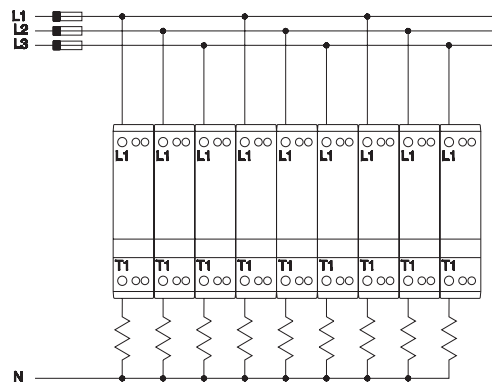

Dimensions (see also page 44)

Type	H	D	W
22.5 mm module	94 mm	124.3 mm	22.5 mm
45 mm module	94 mm	124.3 mm	45 mm
90 mm module	94 mm	124.3 mm	90 mm

Mounting and cable wiring information

Mounting information see page 44 / Cable wiring see page 45

1 Phase electronic contactor (SC 1 L for domestic applications)

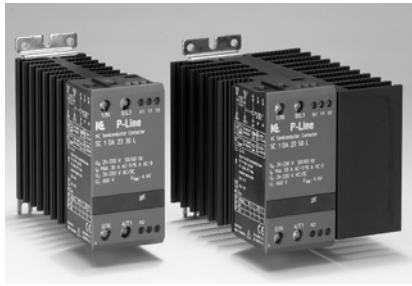

- Electronic contactor for use in domestic applications
- Rated operational voltage up to 480VAC 50/60 Hz
- Rated operational current up to 30 or 50A AC-1
- Control voltage from 24-230 VAC/DC
- Compact modular design 45 or 90 mm
- Meets EN50081-1 / EN50082-2 requirements
- Built-in varistor protection
- IP-20 Protection

Item selection and technical specifications

Load AC-1/51 Heating-element	Load AC-3 Motor	Load AC-55b Lamp	Load AC-56a Trans-former	Control voltage	Item number by 110-230VAC 50/60Hz Line Voltage	Item number by 380-415VAC 50/60Hz Line Voltage	Module-width
				24-230 VAC/DC	SC 1 DA 2330 L	SC 1 DA 4030 L	45mm
				24-230 VAC/DC	SC 1 DA 2350 L		90mm

Output load specification

Min. operational current	10 mA	Filter capacitor / 110-230 VAC	1uF
Leakage current	1 mA AC max.	Filter capacitor current / 110-230 VAC	85/105 mA
		Filter capacitor / 400 VAC	0.68uF
		Filter capacitor current / 400 VAC	100/120 mA
Load power by 30A/110-120VAC	3.3kW	Load power by 50A/230VAC	11.5kW
Load power by 50A/110-120VAC	5.5kW	Load power by 30A/400VAC	12kW
Load power by 30A/230VAC	6.9kW		

Control terminal specifications

Control voltage	24-230 VAC/DC	Control current / power max.	6 mA / 2.5VA@24 VDC
Pick-up voltage max.	20.4 VAC/DC	Max. control voltage	253 VAC/DC
Drop-out voltage min.	7.2 VAC/DC	Response time max.	1 cycle

Thermal specification

Power dissipation for continuous operation PDmax	1.2 W/A	Operation in ambient temperatures exceeding 40°C is possible if the power dissipation is limited either by reducing the steady-state current or by reducing the duty-cycle as shown in the table. Max.cycle time 15min.		
Power dissipation for intermittent operation PD	1.2 W/A x dutycycle			
Cooling method	Natural convection	By 40°C	By 50°C	By 60°C
Mounting	Vertical +/-30°	100% load Duty-cycle 100%	80% load Duty-cycle max. 0.8	70% load Duty-cycle max. 0.65
Operating temperature range EN 60947-4-3	-5°C to 40°C	Environment		
Max. operating temperature with current derating	60°C	Degree of protection	IP 20	Pollution degree
Storage temperature EN 60947-4-3	-20°C to 80°C			3

Insulation specifications

Rated insulation voltage	Ui 660 Volt	EMC This component meets the requirements of the product standard EN 60947-4-3 / EN50081-1, EN50082-2 and is CE marked according to this standard. This products has been designed for class B equipment. Meets EN50081-1 / EN50082-2 requirements. (use of the product in domestic environments)
Rated impulse withstand voltage	Uimp. 4 kVolt	
Installation category	III	

1 Phase electronic contactor (SC 1 L for domestic applications)

Wiring specifications

SC 1 DA XXXX L

11-12: for UP62 or other wiring purposes

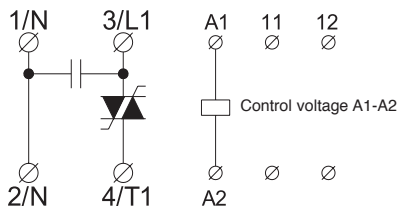

Short-circuit protection by fuses

Two type of short-circuit protection can be used:

Short-circuit protection by fuses

Short-circuit protection is divided into 2 levels **Type 1** or **Type 2**

Co-ordination Type 1: Short-circuit protects the installation

SC 1 DX 2330 L Protection max. 50A gL/gG
 SC 1 DX 2350 L / 4030 L Protection max. 50A gL/gG

Co-ordination Type 2: Short-circuit protects the installation and the semi-conductors inside the motor controller

SC 1 DX XX30 Protection max. i^2t of the fuse 1800 A²S
 SC 1 DX XX50 Protection max. i^2t of the fuse 1800 A²S

Fuses from e.g. Ferraz, Siba, Bussmann can be used as short-circuit protection Type 2

More information concerning Co-ordination Type 2 see page 45

Thermal overload protection (see also page 44)

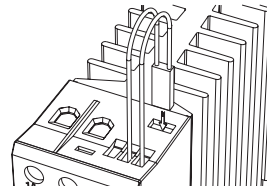

Optional thermal overload protection is possible by inserting a thermostat in a slot on the right hand side of the electronic contactor. Type number UP62

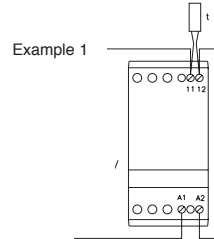

The thermostat can be connected in series with the control circuit of the electronic contactor. When the temperature of the heatsink exceeds 90°C the electronic contactor will switch Off.

Note:

When the temperature has dropped approx. 30°C the electronic contactor will automatically be switched on again.

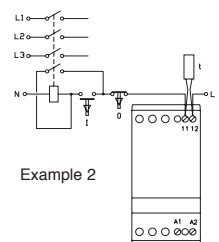

The thermostat is connected in series with the control circuit of the main contactor.

When the temperature of the heatsink exceeds 90°C the main contactor will switch Off.

Note:

A manual reset is necessary to restart this circuit.

Mounting and cable wiring information

Mounting information see page 44 / Cable wiring see page 45

Applications hints SC 1 DA ... L

1-Phase 230 VAC

SC 1 DA 2330 L = 6.9 kW Max
 SC 1 DA 2350 L = 11.5 kW Max

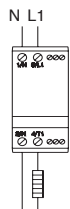

1-Phase 400 VAC

SC 1 DA 4030 L = 12 kW Max



3-Phase with N / 230 VAC

3 x SC 1 DA 2330 L = 20.7 kW Max
 3 x SC 1 DA 2350 L = 34.5 kW Max

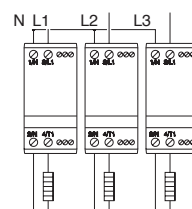

3-Phase without N / 400 VAC

3 x SC 1 DA 4030 L = 36 kW Max

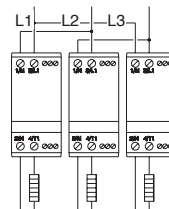

Dimensions (see also page 44)

Type	H	D	W
45 mm module	94 mm	124.3 mm	45 mm
90 mm module	94 mm	124.3 mm	90 mm

1 Phase dual pole electronic contactor (SC 2)

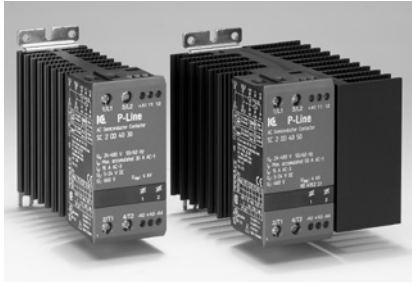

- Rated operational voltage up to 600VAC 50/60 Hz
- Rated operational current up to 30/50A AC-1 (accumulated)
- Control voltage from 5-24 VDC or 24-230 VAC/DC
- Compact modular design 45 or 90 mm
- LED Status indication
- Meets EN 60947-4-3 requirements
- Requires no additional components
- Built-in varistor protection
- IP-20 Protection

Item selection and technical specifications

Load AC-1/51 Heating-element	Load AC-3 Motor	Load AC-55b Lamp	Load AC-56a Transformer	Control voltage	Item number by 12-240VAC 50/60Hz Line Voltage	Item number by 24-480VAC 50/60Hz Line Voltage	Item number by 24-600VAC 50/60Hz Line Voltage	Module-width
30A ¹ accumulated	15A	20A	15A	5-24 VDC	SC 2 DD 2330	SC 2 DD 4030	SC 2 DD 6030	45mm
				24-230 VAC/DC	SC 2 DA 2330	SC 2 DA 4030	SC 2 DA 6030	45mm
50A ¹ accumulated	15A	20A	15A	5-24 VDC	SC 2 DD 2350	SC 2 DD 4050	SC 2 DD 6050	90mm
				24-230 VAC/DC	SC 2 DA 2350	SC 2 DA 4050	SC 2 DA 6050	90mm

¹The indicated loads are accumulated. E.g. the total sum of the current in L1 & L2 (1x30A or 2x15A)

Output load specification

Leakage current	1mA ACmax.	Min. operational current	10mA
Duty cycle	100%		

Control terminal specifications

SC 2 DD XXXX (DC)		SC 2 DA XXXX (AC/DC)	
Control voltage	5-24 VDC	Control voltage	24-230 VAC/DC
Pick-up voltage max.	4.25 VDC	Pick-up voltage max.	20.4 VAC/DC
Drop-out voltage min.	1.5 VDC	Drop-out voltage min.	7.2 VAC/DC
Control current voltage	15 mA@24 VDC	Control current / power max.	6mA / 1.5VA@24 VDC
Max. control voltage	32 VDC	Max. control voltage	253 VAC/DC
Response time max.	1/2 cycle	Response time max.	1 cycle

Thermal specification

Power dissipation for continuous operation PDmax	2.2 W/A accumulated	Operation in ambient temperatures exceeding 40°C is possible if the power dissipation is limited either by reducing the steady-state current or by reducing the duty-cycle as shown in the table. Max.cycle time 15min.		
Power dissipation for intermittent operation PD	2.2 W/A x dutycycle			
Cooling method	Natural convection	By 40°C	By 50°C	By 60°C
Mounting	Vertical +/-30°	100% load Duty-cycle 100%	80% load Duty-cycle max. 0.8	70% load Duty-cycle max. 0.65
Operating temperature range EN 60947-4-3	-5°C to 40°C	Environment		
Max. operating temperature with current derating	60°C	Degree of protection	IP 20	Pollution degree
Storage temperature EN 60947-4-3	-20°C to 80°C			3

Insulation specifications

Rated insulation voltage	Ui 660 Volt	Approval ULc Std No. 508 UL:Use thermal overload protection as required by the National Electric Code. When protected by a non-time delay K5 or H Class fuse, rated 266% of motor FLA, this device is rated for use on a circuit capable of delivering not more than 5,000 rms. symmetrical amperes, 600 V maximum. Maximum surrounding temperature 40°C.
Rated impulse withstand voltage	Uimp. 4 kVolt	
Installation category	III	

1 Phase dual pole electronic contactor (SC 2)

Wiring specifications

SC 2 DX XXXX

11-12: for UP62 or other wiring purposes

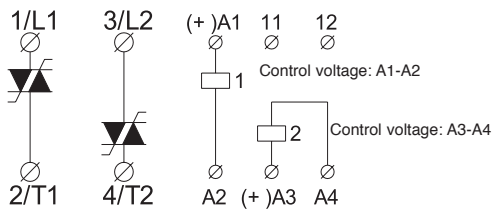

Short-circuit protection by fuses

Two type of short-circuit protection can be used:

Short-circuit protection by fuses

Short-circuit protection is divided into 2 levels **Type 1** or **Type 2**

Co-ordination Type 1: Short-circuit protects the installation

SC 2 DX XX30 Protection max. 50A gL/gG
 SC 2 DX XX50 Protection max. 50A gL/gG

Co-ordination Type 2: Short-circuit protects the installation and the semi-conductors inside the motor controller

SC 2 DX XX30 Protection max. i^2t of the fuse 1800 A²S
 SC 2 DX XX50 Protection max. i^2t of the fuse 1800 A²S

Fuses from e.g. Ferraz, Siba, Bussmann can be used as short-circuit protection Type 2

More information concerning Co-ordination Type 2 see page 45

EMC

This component meets the requirements of the product standard EN 60947-4-3 and is CE marked according to this standard. This products has been designed for class A equipment. Use of the product in domestic environments may cause radio interference, in which case the user may be required to employ additional mitigation methods.

Dimensions (se also page 44)

Type	H	D	W
45 mm module	94 mm	124.3 mm	45 mm

Thermal overload protection (see also page 44)

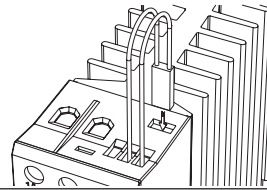

Optional thermal overload protection is possible by inserting a thermostat in a slot on the right hand side of the electronic contactor. Type number UP62

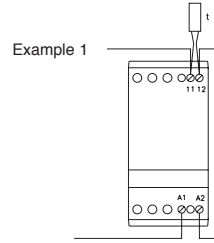

The thermostat can be connected in series with the control circuit of the electronic contactor. When the temperature of the heatsink exceeds 90°C the electronic contactor will switch Off.

Note:

When the temperature has dropped approx. 30°C the electronic contactor will automatically be switched on again.

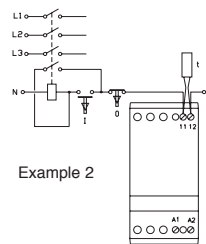

The thermostat is connected in series with the control circuit of the main contactor.

When the temperature of the heatsink exceeds 90°C the main contactor will switch Off.

Note:

A manual reset is necessary to restart this circuit.

Utilisation Categories (EN 60947-4-3)

- AC - 51 Switching of resistive loads
- AC - 55a Switching of electric discharge lamp controls
- AC - 55b Switching of incandescent lamps
- AC - 56a Switching of transformers

Mounting and cable wiring information

Mounting information see page 44 / Cable wiring see page 45

1 Phase dual pole electronic contactor (RC 22 Heatingelement)



- Rated operational voltage up to 480VAC 50/60 Hz
- Rated operational current up to 30 / 50A AC-1 (accumulated)
- Control voltage from 5-24 VDC or 24-230 VAC/DC
- Compact modular design 45 or 90 mm
- LED Status indication
- Meets EN 60947-4-3 requirements
- Requires no additional components
- Built-in varistor protection
- IP-20 Protection

Item selection and technical specifications

Load AC-1/51 Heating-element	Control voltage	Item number by 12-240VAC 50/60Hz Line Voltage	Load in kW by 230V	EAN Nr. 5705 609	Item number by 24-480VAC 50/60Hz Line Voltage	Load in kW by 400V	EAN Nr. 5705 609	Module-width
30A ¹ accumulated	5-24 VDC	RC 22 DD 2330	Max. 6.9 kW	002 282	RC 22 DD 4030	Max. 12.0 kW	002 305	W = 45mm
	24-230 VAC/DC	RC 22 DA 2330			RC 22 DA 4030			002 268
50A ¹ accumulated	5-24 VDC	RC 22 DD 2350	Max. 11.5 kW	002 374	RC 22 DD 4050	Max. 20.0 kW	002 312	W = 90mm
	24-230 VAC/DC	RC 22 DA 2350			RC 22 DA 4050			002 275

¹The indicated loads are accumulated. E.g. the total sum of the current in L1 & L2 (1x30A / 1x 50A or 2x15A / 2x25A)

Output load specification

Leakage current	1mA ACmax.	Min. operational current	10mA
Duty cycle	100%		

Control terminal specifications

RC 22 DD XXXX (DC)		RC 22 DA XXXX (AC/DC)	
Control voltage	5-24 VDC	Control voltage	24-230 VAC/DC
Pick-up voltage max.	4.25 VDC	Pick-up voltage max.	20.4 VAC/DC
Drop-out voltage min.	1.5 VDC	Drop-out voltage min.	7.2 VAC/DC
Control current voltage	15 mA@24 VDC	Control current / power max.	8mA / 2.5VA@24 VDC
Max. control voltage	32 VDC	Max. control voltage	253 VAC/DC
Response time max.	1/2 cycle	Response time max.	1 cycle

Thermal specification

Power dissipation for continuous operation PDmax	1.2 W/A accumulated	Operation in ambient temperatures exceeding 40°C is possible if the power dissipation is limited either by reducing the steady-state current or by reducing the duty-cycle as shown in the table. Max.cycle time 15min.		
Power dissipation for intermittent operation PD	1.2 W/A x dutycycle			
Cooling method	Natural convection	By 40°C	By 50°C	By 60°C
Mounting	Vertical +/-30°	100% load Duty-cycle 100%	80% load Duty-cycle max. 0.8	65% load Duty-cycle max. 0.65
Operating temperature range EN 60947-4-3	-5°C to 40°C			
Max. operating temperature with current derating	60°C			
Storage temperature EN 60947-4-3	-20°C to 80°C			

Environment

Degree of protection	IP 20	Pollution degree	3
----------------------	-------	------------------	---

Insulation specifications

Rated insulation voltage	Ui 660 Volt
Rated impulse withstand voltage	Uimp. 4 kVolt
Installation category	III

1 Phase dual pole electronic contactor (RC 22 Heatingelement)

Wiring specifications

RC 22 DX XXXX

11-12: for UP62 or other wiring purposes

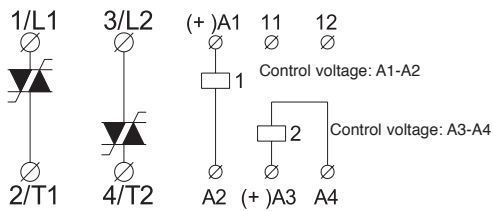

Short-circuit protection by fuses

Two type of short-circuit protection can be used:

Short-circuit protection by fuses

Short-circuit protection is divided into 2 levels **Type 1** or **Type 2**

Co-ordination Type 1: Short-circuit protects the installation
 RC 22 DX XX30 Protection max. 50A gL/gG
 RC 22 DX XX50 Protection max. 50A gL/gG

Co-ordination Type 2: Short-circuit protects the installation and the semi-conductors inside the motor controller
 RC 22 DX XX30 Protection max. i^2t of the fuse 610 A²S
 RC 22 DX XX50 Protection max. i^2t of the fuse 1800 A²S

Fuses from e.g. Ferraz, Siba, Bussmann can be used as short-circuit protection **Type 2**

More information concerning Co-ordination Type 2 see page 45

EMC

This component meets the requirements of the product standard EN 60947-4-3 and is CE marked according to this standard. This products has been designed for class A equipment. Use of the product in domestic environments may cause radio interference, in which case the user may be required to employ additional mitigation methods.

Mounting and cable wiring information

Mounting information see page 44 / Cable wiring see page 45

Thermal overload protection (see also page 44)

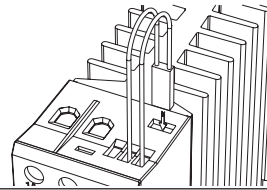

Optional thermal overload protection is possible by inserting a thermostat in a slot on the right hand side of the electronic contactor. Type number UP62

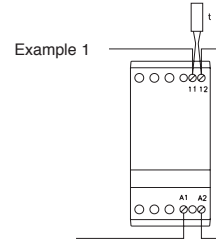

The thermostat can be connected in series with the control circuit of the electronic contactor. When the temperature of the heatsink exceeds 90°C the electronic contactor will switch Off.

Note:

When the temperature has dropped approx. 30°C the electronic contactor will automatically be switched on again.

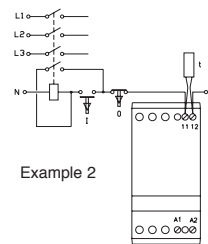

The thermostat is connected in series with the control circuit of the main contactor.

When the temperature of the heatsink exceeds 90°C the main contactor will switch Off.

Note:

A manual reset is necessary to restart this circuit.

Utilisation Categories (EN 60947-4-3)

- AC - 51 Switching of resistive loads
- AC - 55a Switching of electric discharge lamp controls
- AC - 55b Switching of incandescent lamps
- AC - 56a Switching of transformers

Dimensions (se also page 44)

Type	H	D	W
45 mm module	94 mm	124.3 mm	45 mm
90 mm module	94 mm	124.3 mm	90 mm

3 Phase dual pole electronic contactor (RC 32 Heatingelement)

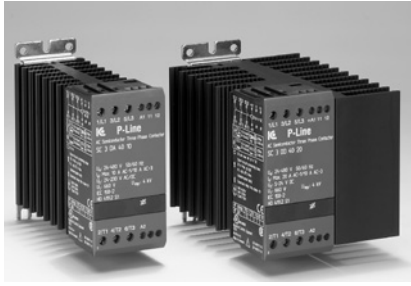

- Rated operational voltage up to 480VAC 50/60 Hz
- Rated operational current up to 15 / 25A AC-1
- Control voltage from 5-24 VDC or 24-230 VAC/DC
- Compact modular design 45 or 90 mm
- LED Status indication
- Meets EN 60947-4-3 requirements
- Requires no additional components
- Built-in varistor protection
- IP-20 Protection

Item selection and technical specifications

Load AC-1/51 Heating-element	Control voltage	Item number by 12-240VAC 50/60Hz Line Voltage	Load in kW by 230V	EAN Nr. 5705 609	Item number by 24-480VAC 50/60Hz Line Voltage	Load in kW by 400V	EAN Nr. 5705 609	Module-width
15A	5-24 VDC				RC 32 DD 4015	Max. 10.4 kW	002 428 002 404	W = 45mm
	24-230 VAC/DC				RC 32 DA 4015			W = 45mm
25A	5-24 VDC				RC 32 DD 4025	Max. 17.3 kW	002 435 002 411	W = 90mm
	24-230 VAC/DC				RC 32 DA 4025			W = 90mm

Output load specification

Leakage current	1mA ACmax.	Min. operational current	10mA
Duty cycle	100%		

Control terminal specifications

RC 32 DD 40XX (DC)		RC 32 DA 40XX (AC/DC)	
Control voltage	5-24 VDC	Control voltage	24-230 VAC/DC
Pick-up voltage max.	4.25 VDC	Pick-up voltage max.	20.4 VAC/DC
Drop-out voltage min.	1.5 VDC	Drop-out voltage min.	7.2 VAC/DC
Control current voltage	20 mA@24 VDC	Control current / power max.	8mA / 2.5VA@24 VDC
Max. control voltage	32 VDC	Max. control voltage	253 VAC/DC
Response time max.	1/2 cycle	Response time max.	1 cycle

Thermal specification

Power dissipation for continuous operation PDmax	2.4 W/A	Operation in ambient temperatures exceeding 40°C is possible if the power dissipation is limited either by reducing the steady-state current or by reducing the duty-cycle as shown in the table. Max.cycle time 15min.		
Power dissipation for intermittent operation PD	2.4 W/A x dutycycle			
Cooling method	Natural convection	By 40°C	By 50°C	By 60°C
Mounting	Vertical +/-30°	100% load Duty-cycle 100%	80% load Duty-cycle max. 0.8	65% load Duty-cycle max. 0.65
Operating temperature range EN 60947-4-3	-5°C to 40°C			
Max. operating temperature with current derating	60°C			
Storage temperature EN 60947-4-3	-20°C to 80°C			

Environment

Degree of protection	IP 20	Pollution degree	3
----------------------	-------	------------------	---

Insulation specifications

Rated insulation voltage	Ui 660 Volt
Rated impulse withstand voltage	Uimp. 4 kVolt
Installation category	III

3 Phase dual pole electronic contactor (RC 32 Heatingelement)

Wiring specifications

RC 32 DX 40XX

11-12: for UP62 or other wiring purposes

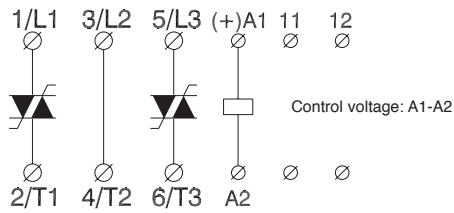

Short-circuit protection by fuses

Two type of short-circuit protection can be used:

Short-circuit protection by fuses

Short-circuit protection is divided into 2 levels **Type 1** or **Type 2**

Co-ordination Type 1: Short-circuit protects the installation

RC 32 DX 4015 Protection max. 50A gL/gG
RC 32 DX 4025 Protection max. 50A gL/gG

Co-ordination Type 2: Short-circuit protects the installation and the semi-conductors inside the motor controller

RC 32 DX 4015 Protection max. i^2t of the fuse 610 A²S
RC 32 DX 4025 Protection max. i^2t of the fuse 610 A²S

Fuses from e.g. Ferraz, Siba, Bussmann can be used as short-circuit protection Type 2

More information concerning Co-ordination Type 2 see page 45

EMC

This component meets the requirements of the product standard EN 60947-4-3 and is CE marked according to this standard. This products has been designed for class A equipment. Use of the product in domestic environments may cause radio interference, in which case the user may be required to employ additional mitigation methods.

Mounting and cable wiring information

Mounting information see page 44 / Cable wiring see page 45

Thermal overload protection (see also page 44)

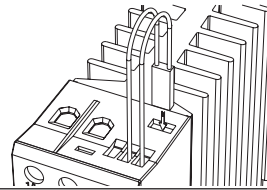

Optional thermal overload protection is possible by inserting a thermostat in a slot on the right hand side of the electronic contactor. Type number UP62

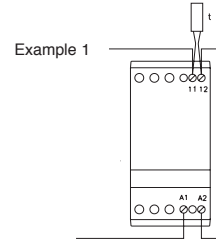

The thermostat can be connected in series with the control circuit of the electronic contactor. When the temperature of the heatsink exceeds 90°C the electronic contactor will switch Off.

Note:

When the temperature has dropped approx. 30°C the electronic contactor will automatically be switched on again.

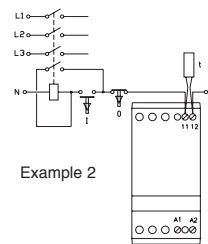

The thermostat is connected in series with the control circuit of the main contactor.

When the temperature of the heatsink exceeds 90°C the main contactor will switch Off.

Note:

A manual reset is necessary to restart this circuit.

Utilisation Categories (EN 60947-4-3)

- AC - 51 Switching of resistive loads
- AC - 55a Switching of electric discharge lamp controls
- AC - 55b Switching of incandescent lamps
- AC - 56a Switching of transformers

Dimensions (se also page 44)

Type	H	D	W
45 mm module	94 mm	124.3 mm	45 mm
90 mm module	94 mm	124.3 mm	90 mm

3 Phase electronic contactor (SC 3)



- Rated operational voltage up to 600VAC 50/60 Hz
- Rated operational current up to 10, 15 and 20 A AC-1
- Control voltage from 5-24 VDC or 24-230 VAC/DC
- Compact modular design 45 or 90 mm
- LED Status indication
- Meets EN 60947-4-3 requirements
- Requires no additional components
- Built-in varistor protection
- IP-20 Protection

Item selection and technical specifications

Load AC-1/51 Heating-element	Load AC-3 Motor	Load AC-55b Lamp	Load AC-56a Transformer	Control voltage	Item number by 12-240VAC 50/60Hz Line Voltage	Item number by 24-480VAC 50/60Hz Line Voltage	Item number by 24-600VAC 50/60Hz Line Voltage	Module-width
10A	10A	10A	5A	5-24 VDC 24-230 VAC/DC	SC 3 DD 2310 SC 3 DA 2310	SC 3 DD 4010 SC 3 DA 4010	SC 3 DD 6010 SC 3 DA 6010	45mm 45mm
* 15A	10A	10A	5A	5-24 VDC 24-230 VAC/DC		SC 3 DD 4015 * SC 3 DA 4015 *		45mm 45mm
20A	10A	10A	5A	5-24 VDC 24-230 VAC/DC	SC 3 DD 2320 SC 3 DA 2320	SC 3 DD 4020 SC 3 DA 4020	SC 3 DD 6020 SC 3 DA 6020	90mm 90mm

Output load specification

Leakage current	1mA ACmax.	Min. operational current	10mA
Duty cycle	100%		

Control terminal specifications

SC 3 DD XXXX (DC)		SC 3 DA XXXX (AC/DC)	
Control voltage	5-24 VDC	Control voltage	24-230 VAC/DC
Pick-up voltage max.	4.25 VDC	Pick-up voltage max.	20.4 VAC/DC
Drop-out voltage min.	1.5 VDC	Drop-out voltage min.	7.2 VAC/DC
Control current voltage	15 mA@24 VDC	Control current / power max.	6mA / 1.5VA@24 VDC
Max. control voltage	32 VDC	Max. control voltage	253 VAC/DC
Response time max. (ON/OFF)	1/2 cycle	Response time max. (ON/OFF)	1 cycle

Thermal specification

Power dissipation for continuous operation PDmax	3.3 W/A	Operation in ambient temperatures exceeding 40°C is possible if the power dissipation is limited either by reducing the steady-state current or by reducing the duty-cycle as shown in the table. Max.cycle time 15min.		
Power dissipation for intermittent operation PD	3.3 W/A x dutycycle			
Cooling method	Natural convection	By 40°C	By 50°C	By 60°C
Mounting	Vertical +/-30°	100% load Duty-cycle 100%	80% load Duty-cycle max. 0.8	70% load Duty-cycle max. 0.65
Operating temperature range EN 60947-4-3	-5°C to 40°C			
Max. operating temperature with current derating	60°C			
Storage temperature EN 60947-4-3	-20°C to 80°C			

Environment

Degree of protection	IP 20	Pollution degree	3
----------------------	-------	------------------	---

Approval

cUL Std No. 508 (**Not approved SC3DX4015**)
 UL: Use thermal overload protection as required by the National Electric Code. When protected by a non-time delay K5 or H Class fuse, rated 266% of motor FLA, this device is rated for use on a circuit capable of delivering not more than 5,000 rms. symmetrical amperes, 600 V maximum. Maximum surrounding temperature 40°C.

Insulation specifications

Rated insulation voltage	Ui 660 Volt
Rated impulse withstand voltage	Uimp. 4 kVolt
Installation category	III

* Not cUL approved

3 Phase electronic contactor (SC 3)

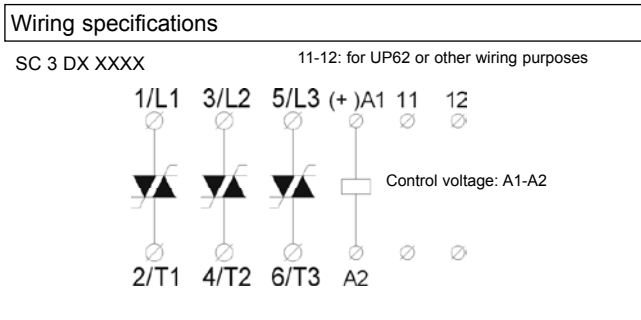

Short-circuit protection by fuses

Two type of short-circuit protection can be used:

Short-circuit protection by fuses
Short-circuit protection is divided into 2 levels Type 1 or Type 2

Co-ordination Type 1: Short-circuit protects the installation
 SC 3 DX XX10 Protection max. 50A gL/gG
 SC 3 DX 4015 Protection max. 50A gL/gG
 SC 3 DX XX20 Protection max. 50A gL/gG

Co-ordination Type 2: Short-circuit protects the installation and the semiconductors inside the motor controller
 SC 3 DX XX10 Protection max. i^2t of the fuse 610 A²S
 SC 3 DX 4015 Protection max. i^2t of the fuse 610 A²S
 SC 3 DX XX20 Protection max. i^2t of the fuse 610 A²S

Fuses from e.g. Ferraz, Siba, Bussmann can be used as short-circuit protection Type 2

More information concerning Co-ordination Type 2 see page 45

EMC

This component meets the requirements of the product standard EN 60947-4-3 and is CE marked according to this standard. This products has been designed for class A equipment. Use of the product in domestic environments may cause radio interference, in which case the user may be required to employ additional mitigation methods.

Mounting and cable wiring information

Mounting information see page 44 / Cable wiring see page 45

Thermal overload protection (see also page 44)

Optional thermal overload protection is possible by inserting a thermostat in a slot on the right hand side of the electronic contactor. Type number UP62

Example 1

The thermostat can be connected in series with the control circuit of the electronic contactor. When the temperature of the heatsink exceeds 90°C the electronic contactor will switch Off.
Note: When the temperature has dropped approx. 30°C the electronic contactor will automatically be switched on again.

Example 2

The thermostat is connected in series with the control circuit of the main contactor. When the temperature of the heatsink exceeds 90°C the main contactor will switch Off.
Note: A manual reset is necessary to restart this circuit.

Utilisation Categories (EN 60947-4-3)

AC - 51 Switching of resistive loads
 AC - 55a Switching of electric discharge lamp controls
 AC - 55b Switching of incandescent lamps
 AC - 56a Switching of transformers

Dimensions (se also page 44)

Type	H	D	W
45 mm module	94 mm	124.3 mm	45 mm
90 mm module	94 mm	124.3 mm	90 mm

3 Phase electronic contactor (RC 33 Heatingelement)



- Rated operational voltage up to 480VAC 50/60 Hz
- Rated operational current up to 10 / 20A AC-1
- Control voltage from 5-24 VDC or 24-230 VAC/DC
- Compact modular design 45 or 90 mm
- LED Status indication
- Meets EN 60947-4-3 requirements
- Requires no additional components
- Built-in varistor protection
- IP-20 Protection

Item selection and technical specifications

Load AC-1/51 Heating-element	Control voltage	Item number by 12-240VAC 50/60Hz Line Voltage	Load in kW by 230V	EAN Nr. 5705 609	Item number by 24-480VAC 50/60Hz Line Voltage	Load in kW by 400V	EAN Nr. 5705 609	Module-width
10A	5-24 VDC	RC 33 DD 2310	Max. 4.0 kW	002 367	RC 33 DD 4010	Max. 6.9 kW	002 381	W = 45mm
	24-230 VAC/DC	RC 33 DA 2310			RC 33 DA 4010			002 343
20A	5-24 VDC	RC 33 DD 2320	Max. 8.0 kW	002 374	RC 33 DD 4020	Max. 13.9 kW	002 398	W = 90mm
	24-230 VAC/DC	RC 33 DA 2320			RC 33 DA 4020			002 350

Output load specification

Leakage current	1mA ACmax.	Min. operational current	10mA
Duty cycle	100%		

Control terminal specifications

RC 33 DD XXXX (DC)		RC 33 DA XXXX (AC/DC)	
Control voltage	5-24 VDC	Control voltage	24-230 VAC/DC
Pick-up voltage max.	4.25 VDC	Pick-up voltage max.	20.4 VAC/DC
Drop-out voltage min.	1.5 VDC	Drop-out voltage min.	7.2 VAC/DC
Control current voltage	25 mA@24 VDC	Control current / power max.	8mA / 2.5VA@24 VDC
Max. control voltage	32 VDC	Max. control voltage	253 VAC/DC
Response time max. (ON/OFF)	1/2 cycle	Response time max. (ON/OFF)	1 cycle

Thermal specification

Power dissipation for continuous operation PDmax	3.6 W/A	Operation in ambient temperatures exceeding 40°C is possible if the power dissipation is limited either by reducing the steady-state current or by reducing the duty-cycle as shown in the table. Max.cycle time 15min.		
Power dissipation for intermittent operation PD	3.6 W/A x dutycycle			
Cooling method	Natural convection	By 40°C	By 50°C	By 60°C
Mounting	Vertical +/-30°	100% load Duty-cycle 100%	80% load Duty-cycle max. 0.8	65% load Duty-cycle max. 0.65
Operating temperature range EN 60947-4-3	-5°C to 40°C			
Max. operating temperature with current derating	60°C			
Storage temperature EN 60947-4-3	-20°C to 80°C			

Environment

Degree of protection	IP 20	Pollution degree	3
----------------------	-------	------------------	---

Insulation specifications

Rated insulation voltage	Ui 660 Volt
Rated impulse withstand voltage	Uimp. 4 kVolt
Installation category	III

3 Phase electronic contactor (RC 33 Heatingelement)

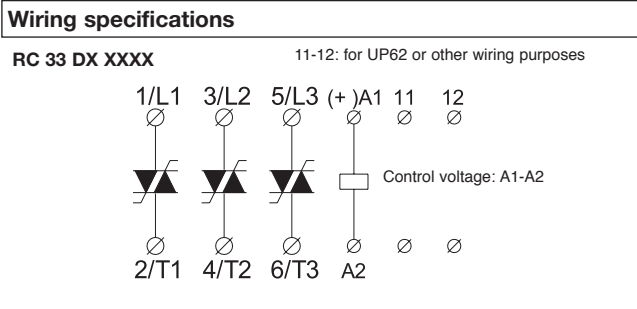

Short-circuit protection by fuses

Two type of short-circuit protection can be used:

Short-circuit protection by fuses
Short-circuit protection is divided into 2 levels **Type 1** or **Type 2**

Co-ordination Type 1: Short-circuit protects the installation
RC 3 DX XX10 Protection max. 50A gL/gG
RC 3 DX XX20 Protection max. 50A gL/gG

Co-ordination Type 2: Short-circuit protects the installation and the semi-conductors inside the motor controller
RC 3 DX XX10 Protection max. i^2t of the fuse 610 A²S
RC 3 DX XX20 Protection max. i^2t of the fuse 610 A²S

Fuses from e.g. Ferraz, Siba, Bussmann can be used as short-circuit protection **Type 2**

More information concerning Co-ordination Type 2 see page 45

EMC

This component meets the requirements of the product standard EN 60947-4-3 and is CE marked according to this standard. This products has been designed for class A equipment. Use of the product in domestic environments may cause radio interference, in which case the user may be required to employ additional mitigation methods.

Mounting and cable wiring information

Mounting information see page 44 / Cable wiring see page 45

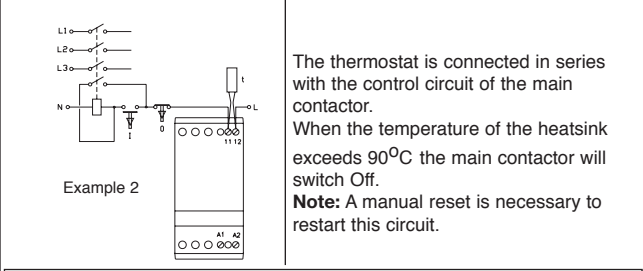
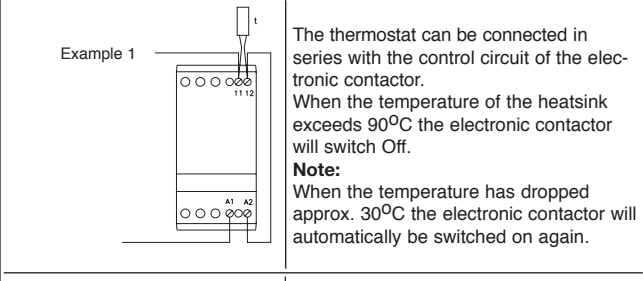
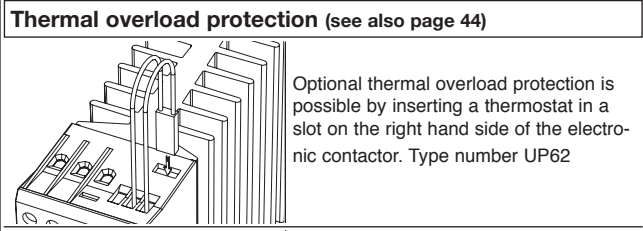

Utilisation Categories (EN 60947-4-3)

- AC - 51 Switching of resistive loads
- AC - 55a Switching of electric discharge lamp controls
- AC - 55b Switching of incandescent lamps
- AC - 56a Switching of transformers

Dimensions (se also page 44)

Type	H	D	W
45 mm module	94 mm	124.3 mm	45 mm
90 mm module	94 mm	124.3 mm	90 mm

1 Phase electronic analogue power controller (SPC 1)



- Analogue controller for accurate process control
- Phase angle or burst firing control of heaters, lamps, trafos
- Rated operational voltage range: 230VAC, 480VAC
- Rated operational current up to 30A or 50A AC1
- Current Loop Control: 0-20mA, 4-20 mA
- Voltage Control: 0-10 VDC
- Manual Control: 10 kohm potentiometer
- Reverse action operation possible

Item selection and technical specifications

Load AC-1/51 Heating-element	Load AC-3 Motor*	Load AC-55b Lamp	Load AC-56a Transformer	Analogue control input signal	Item number by 110-127VAC 50/60Hz Line Voltage	Item number by 208-230VAC 50/60Hz Line Voltage	Item number by 380-480VAC 50/60Hz Line Voltage	Module-width
30A	15A	30A	30A	0-20 / 20-0 mA, 4-20 / 20-4 mA 0-10 / 10-0 VDC, 0-10 / 10-0 kohm		SPC 1 AD 2330	SPC 1 AD 4030	45mm
50A	15A	30A	30A			SPC 1 AD 2350	SPC 1 AD 4050	90mm

Output load specification

Leakage current	1mA ACmax.	Min. operational current	10mA
Duty cycle	100%		
Load power by 30A / 120VAC	0-3.6kW	Load power by 50A / 120VAC	0-6kW
Load power by 30A / 230VAC	0-6.9kW	Load power by 50A / 230VAC	0-11.5kW
Load power by 30A / 400VAC	0-12kW	Load power by 50A / 400VAC	0-20kW

Control terminal specifications

Current Loop Control Voltage drop 3 Volt Max.	0 - 20 mA / 20 - 0 mA	Manual Control with potentiometer	0-10 kohm / 10-0 kohm
Current Loop Control Voltage drop 3 Volt Max.	4 - 20 mA / 20 - 4 mA		
Voltage Control Input resistance 300 kohm min.	0-10 V / 10-0 V	Control Voltage supply	24VAC/24VDC max. 30 mA

Thermal specification

Power dissipation for continuous operation PDmax	1.2 W/A	Operation in ambient temperatures exceeding 40°C is possible if the power dissipation is limited either by reducing the steady-state current or by reducing the duty-cycle as shown in the table. Max.cycle time 15min.		
Power dissipation for intermittent operation PD	1.2 W/A x dutycycle			
Cooling method	Natural convection	By 40°C	By 50°C	By 60°C
Mounting	Vertical +/-30°	100% load Duty-cycle 100%	80% load Duty-cycle max. 0.8	70% load Duty-cycle max. 0.65
Operating temperature range EN 60947-4-3	-5°C to 40°C	Environment		
Max. operating temperature with current derating	60°C	Degree of protection	IP 20	Pollution degree
Storage temperature EN 60947-4-3	-20°C to 80°C			3

Insulation specifications

Rated insulation voltage	Ui 660 Volt	cUL Std No. 508 (*No UL approval for AC 3 motor load) UL:Use thermal overload protection as required by the National Electric Code. When protected by a non-time delay K5 or H Class fuse, rated 266% of motor FLA, this device is rated for use on a circuit capable of delivering not more than 5,000 rms. symmetrical amperes, 600 V maximum. Maximum surrounding temperature 40°C.
Rated impulse withstand voltage	Uimp. 4 kVolt	
Installation category	III	

1 Phase electronic analogue power controller (SPC 1)

Wiring specifications

SPC 1 AD

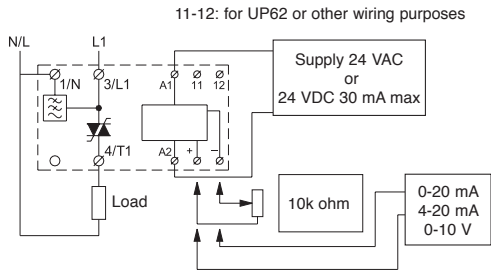

Short-circuit protection by fuses

Two type of short-circuit protection can be used:

Short-circuit protection by fuses

Short-circuit protection is divided into 2 levels **Type 1** or **Type 2**

Co-ordination Type 1: Short-circuit protects the installation

SPC 1 AD XX30 Protection max. 50A gL/gG
SPC 1 AD XX50 Protection max. 50A gL/gG

Co-ordination Type 2: Short-circuit protects the installation and the semi-conductors inside the motor controller

SPC 1 AD XX30 Protection max. i^2t of the fuse 1800 A²S
SPC 1 AD XX50 Protection max. i^2t of the fuse 1800 A²S

Fuses from e.g. Ferraz, Siba, Bussmann can be used as short-circuit protection Type 2

More information concerning Co-ordination Type 2 see page 45

EMC

This component meets the requirements of the product standard EN 60947-4-3 and is CE marked according to this standard. This products has been designed for class A equipment. Use of the product in domestic environments may cause radio interference, in which case the user may be required to employ additional mitigation methods.

Mounting and cable wiring information

Mounting information see page 44 / Cable wiring see page 45

Application hints and general specifications

See page 40-41

Thermal overload protection (see also page 44)

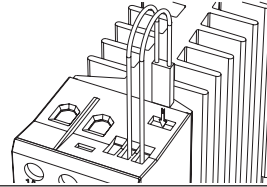

Optional thermal overload protection is possible by inserting a thermostat in a slot on the right hand side of the electronic contactor. Type number UP62

Example 1

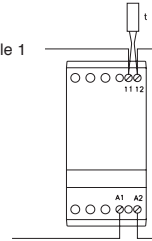

The thermostat can be connected in series with the control circuit of the electronic contactor. When the temperature of the heatsink exceeds 90°C the electronic contactor will switch Off.

Note:

When the temperature has dropped approx. 30°C the electronic contactor will automatically be switched on again.

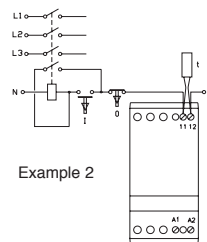

Example 2

The thermostat is connected in series with the control circuit of the main contactor.

When the temperature of the heatsink exceeds 90°C the main contactor will switch Off.

Note:

A manual reset is necessary to restart this circuit.

Utilisation Categories (EN 60947-4-3)

AC - 51 Switching of resistive loads

AC - 55a Switching of electric discharge lamp controls

AC - 55b Switching of incandescent lamps

AC - 56a Switching of transformers

Dimensions (see also page 44)

Type	H	D	W
45 mm module	94 mm	124.3 mm	45 mm
90 mm module	94 mm	124.3 mm	90 mm

Application hints analogue power controller for SPC 1

Control mode selection

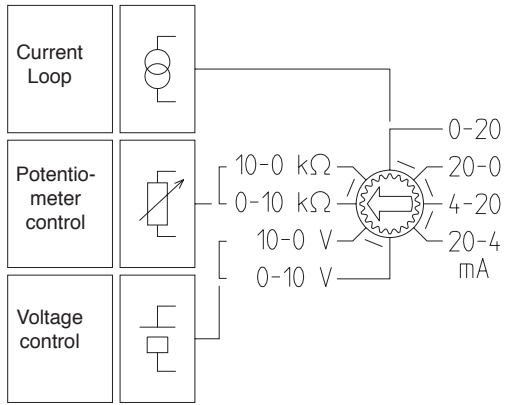

Current Loop	0	20 mA
	20	0 mA
	4	20 mA
	20	4 mA
Voltage	0	10 V
	10	0 V
Potentiometer	0	10 kohm
	10	0 kohm

Selection of control signal
The type of control signal, Current, Voltage or Potentiometer, can be selected on the rotary switch.

Protection
The control inputs are protected against overload. If the current exceeds 25 mA the loop will be switched Off and the LED's will indicate failure. The input will not be damaged if the 24 V supply by mistake is connected to the signal input. Control input terminals are marked with + correct polarity must be observed. The control input is floating.

Isolation Voltage:
Line to Control: 2.5kV AC

Isolation Voltage:
Supply to Control: 500V AC

Function mode selection

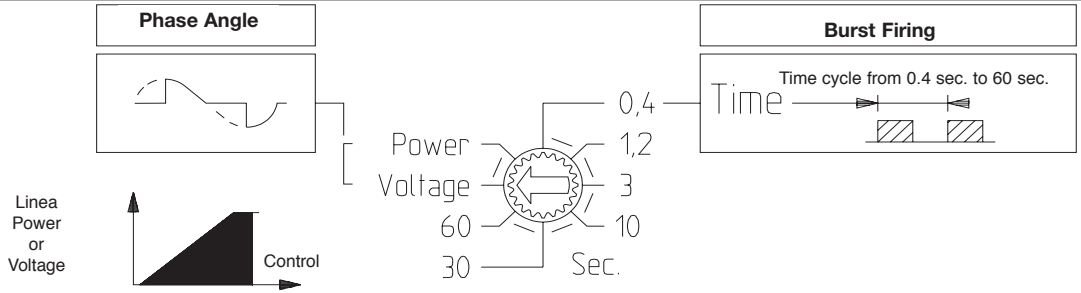

Phase Angle: Phase angle control is used for control of infrared lamps or heaters in IR heating applications
Two different operation modes can be selected.
Lin. Voltage: The load voltage varies linearly with the control signal
Lin. Power: The power delivered to the load varies linearly with the control signal.

Burst Firing
In Burst Firing mode full sine waves are supplied to the load. Consequently DC magnetising of the supply transformer is avoided. The number of sine waves varies linearly with the control signal. Adjustable cycle times from 400 ms to 60 sec.

Line and load wiring hints for 1 or 3 phase application with or without neutral

Single Phase 230 / 400 V AC
Phase Angle and Burst Firing applications
230 and 400 V Heaters

Three Phase with Neutral
Phase Angle and Burst Firing for heater applications

Three Phase without Neutral Economy
With single pole contactor SC1DA4030 as slave.
Only Burst Firing applications.

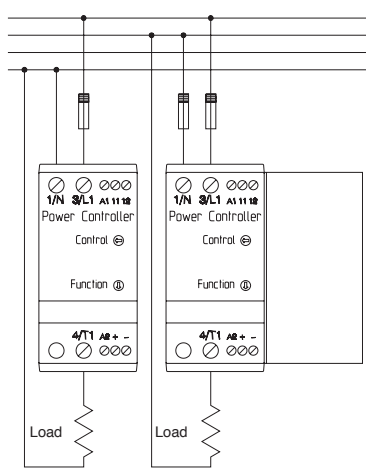

SPC1AD 2330= 6.9kW/SPC1AD 4030= 12kW Max
SPC1AD 2350= 11.5kW/SPC1AD 4050= 20kW Max

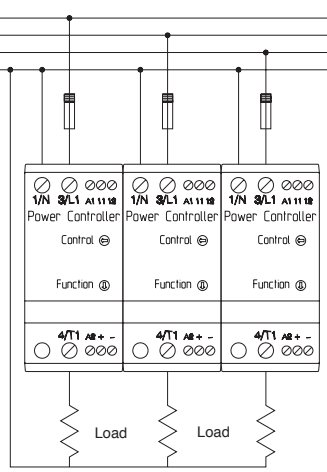

3 x SPC1AD 2330 = 20.7kW Max
3 x SPC1AD 2350 = 34.5kW Max

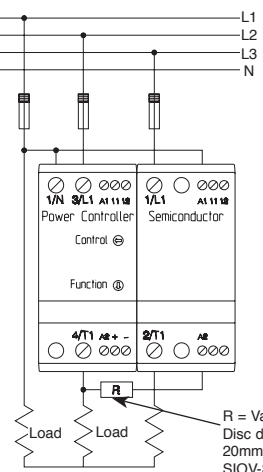

SPC1AD 4030 + SC1DA 4030= 20.7kW Max
SPC1AD 4050 + SC1DA 4050= 34.5kW Max

R = Varistor 230 VAC.
Disc diameter min 20mm e.g. Siemens S10V-S20K230

Application hints analogue power controller for SPC 1

Different applications hints

Current Loop:

0-20 mA or 4-20 mA. Controller inputs must be connected in series

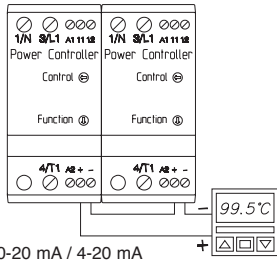

Voltage Control :

Controller inputs must be connected in parallel

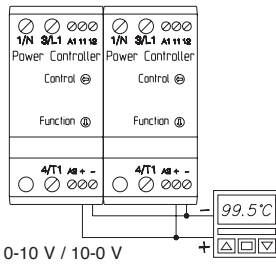

Potentiometer Control :

10 kohm linear potentiometer

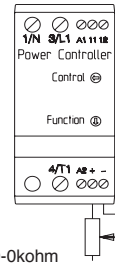

Control Supply :

Controller supply must be connected in parallel

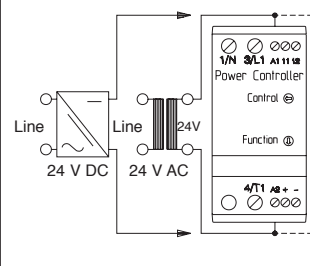

Transformer applications hints

Transformer Loads

SPC1 load driving capability includes transformer applications which means that low voltage loads can be controlled via an isolation transformer without any surge or DC magnetising of the transformer

Switching Transformers

The problem in transformer switching is the magnetic circuit. When the transformer is switched Off, (H=0) the field (B) remains on a high level due to the high remanence of modern transformer core material. At initial turn-On where the remanence is unknown the SPC1 will soft-start to avoid the high current surge and at repetitive turn-on the switch-off polarity is "remembered" so next turn-on will be in the opposite polarity, thereby eliminating the high current surge normally seen in transformer applications. DC magnetising is eliminated by operating in full cycle mode only

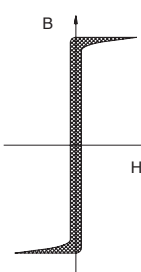
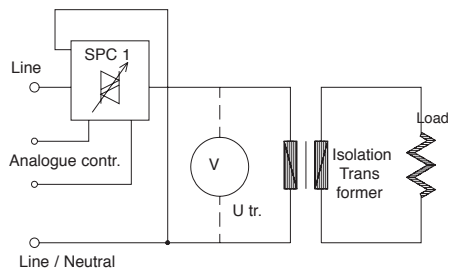

Phase Angle Mode :

A initial turn On SPC 1 will soft-start the transformer to the voltage level set by the analogue input.

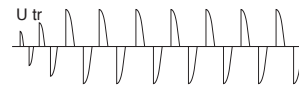

Burst Firing Mode :

A initial turn On SPC 1 will soft-start the transformer to full On mode. The controller will only allow full cycles to be supplied to the transformer hereby eliminating current surges and DC saturation of the transformer.

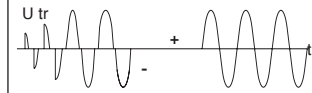

Transformer applications hints

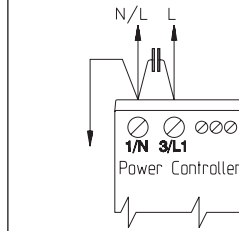
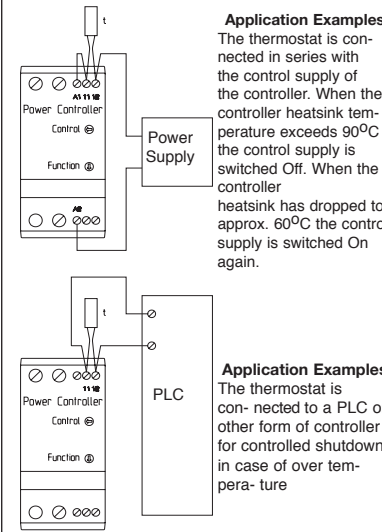
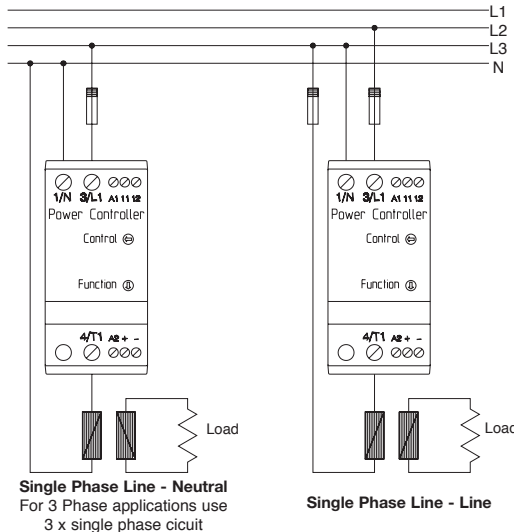

EMC Specifications

SPC 1 is in conformity with EN60947-4-3 AC Semiconductor Contactors for non motor loads

Burst Firing Control Mode:

No action necessary.

Phase Angle Control Mode: I < 10 A

No action necessary. Internal filter is sufficient.

Phase Angle Control Mode: I > 10 A

Connect 1uF capacitor from N/L to L1 as shown above.

AC Auxiliary contact module (MAUX)



- Full-On monitoring of soft starters (SMC 3, SMC 33, STL)
- Function monitoring of Electronic Contactors (SC X)
- Function monitoring of motor reversing & motor contactors (SRC/DOL)
- Full-On/Off monitoring of Analogue Power Controller (SPC 1 AD)
- Dual Voltage range 230 VAC or 400 - 600 VAC 50/60 Hz
- Relay output (NO / NC) 5A 250VAC / 3A 24 VDC
- 22.5 mm module for DIN-rail mounting
- LED status indication
- IP-20 Protection

Item selection and technical specifications

MAUX 01 600 is an auxiliary module for monitoring the status of a connected motor controller or electronic contactor. If the sense voltage across the semiconductor on the connected controller (T3 and L3) is lower than 2 VAC the output relay is switched On (NC / 11-14). The output relay will open again (NO / 11-12) when the sense voltage is higher than 2.5 VAC.

Output specifications

Relay Output 5A 250 VAC (AC-22) 3A 24 VDC (DC22)

Line voltage range

Line voltage range	Item No.
T2.1 - T3 208 - 240 VAC 50/60 Hz Max 10 VA 1.5 W	MAUX 01 A 600
T2.2 - T3 380 - 600 VAC 50/60 Hz Max 35 VA 2.5 W	

Environment

Degree of protection	IP 20	Pollution degree	3
----------------------	-------	------------------	---

Insulation specifications

Rated insulation voltage	Ui 660 Volt
Rated impulse withstand voltage	Uimp. 4 kVolt
Installation category	III

Functional diagram



Block diagram

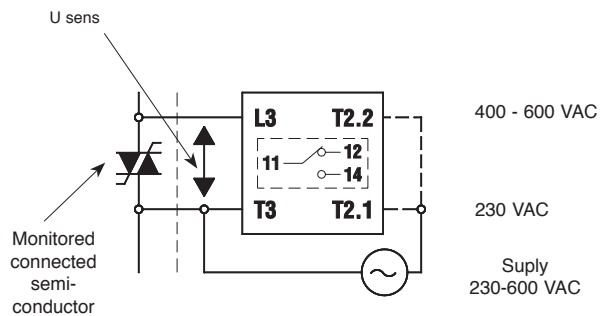

Semiconductor voltage timing diagram

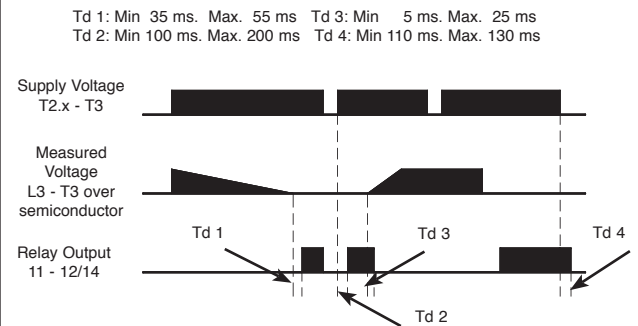

App. Ex. STL 3 3-ph 400 V

Full-ON Monitoring with Starting Torque Limiter Type STL 3 3 Phase Motor 400 / 600 VAC

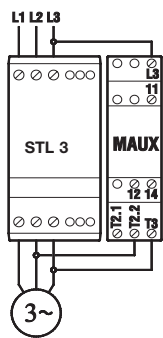

App. Ex. STL3 3-ph 230 V

Full-ON Monitoring with Starting Torque Limiter Type STL 3 3 Phase Motor 230 VAC

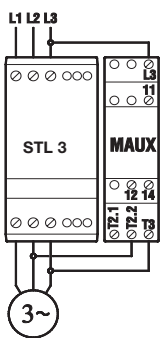

App. Ex. STL1 1-ph 230 V

Full-ON Monitoring with Starting Torque Limiter Type STL 1 1 Phase Motor 230 VAC

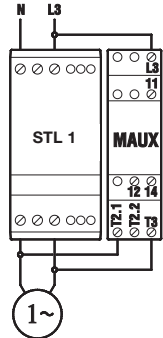

App. Ex. SC 3 3-ph 400 V

Full-ON Monitoring with 3 Ph. Contactor Type SC 3 3 Phase Motor 400 / 600 VAC

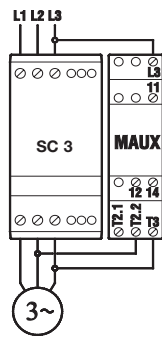

AC Auxiliary contact module (MAUX)

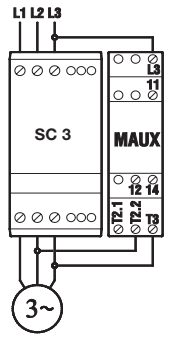
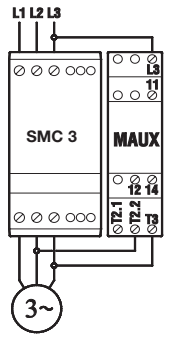
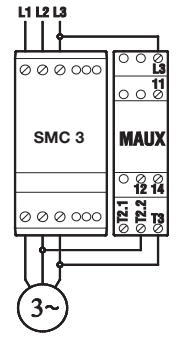
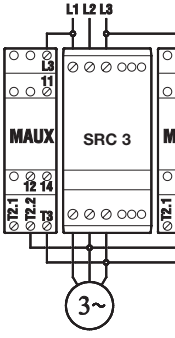
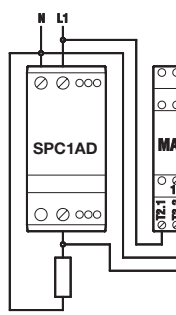
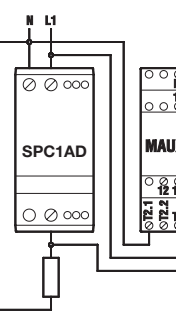
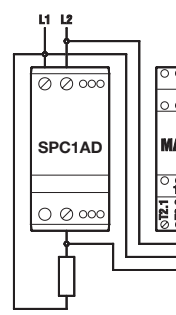
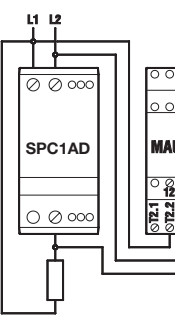
<p>App. Ex. SC 3 3-ph 230 V</p> <p>ON Monitoring with 3 Ph. Contactor Type SC 3 3 Phase Motor 230 VAC</p> 	<p>App. Ex. SMC 3 3-ph 400 V</p> <p>Full-ON Monitoring with Soft Starter Type SMC 3 3 Phase Motor 400 / 600 VAC</p> 	<p>App. Ex. SMC 3 3-ph 230 V</p> <p>Full-ON Monitoring with Soft Starter Type SMC 3 3 Phase Motor 230 VAC</p> 	<p>App. Ex. SRC 3 3-ph 400 V</p> <p>ON Monitoring with Reversing Type SRC 3 Phase Motor 400 VAC</p> 
<p>App. Ex. SPC 1 1-ph 230 V</p> <p>Full-OFF Monitoring with Analogue Contactor Type SPC1 230VAC</p> 	<p>App. Ex. SPC 1 1-ph 230 V</p> <p>Full-ON Monitoring with Analogue Contactor Type SPC1 230 VAC</p> 	<p>App. Ex. SPC 1 3-ph 400 V</p> <p>Full-OFF Monitoring with Analogue Contactor Type SPC1 400 VAC</p> 	<p>App. Ex. SPC 1 3-ph 400 V</p> <p>Full-ON Monitoring with Analogue Contactor Type SPC1 400 VAC</p> 

Application example. soft starter type SMC 3 / SMC 33 with control of by-pass contactor

Control of by-pass Contactor (functional description): When the Control signal A1-A2 is supplied to the Soft Starter, Ram-Up is initiated. When the ramp time has elapsed the output relay in the MAUX1 will switch the by-pass contactor ON for limiting the power dissipation in the Soft Starter. When the control voltage is switched OFF the by-pass contactor will drop instantaneously, before the semiconductors are switched off, for eliminating severe arcing in the mechanical contactor. In this application the by-pass contactor can be selected from the thermal current Ith rating and not from the AC-3 rating.

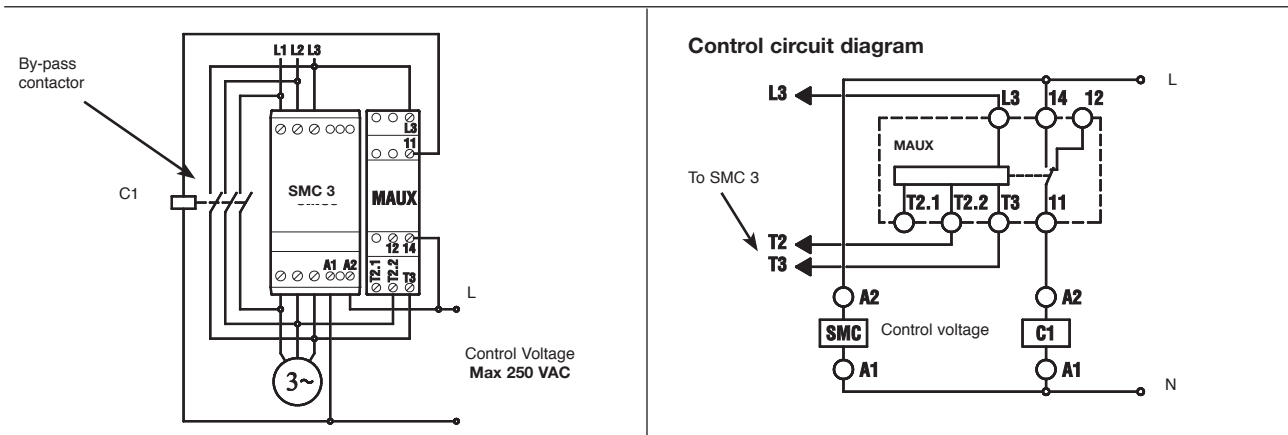

Control circuit diagram

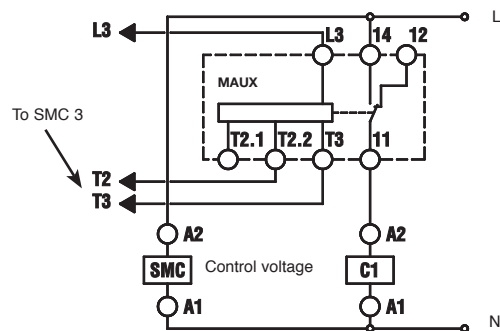

Dimensions, weight, mounting and wiring instruction

Dimensions 22.5 mm module (SC1/RC11/SMC 3 3,5A)

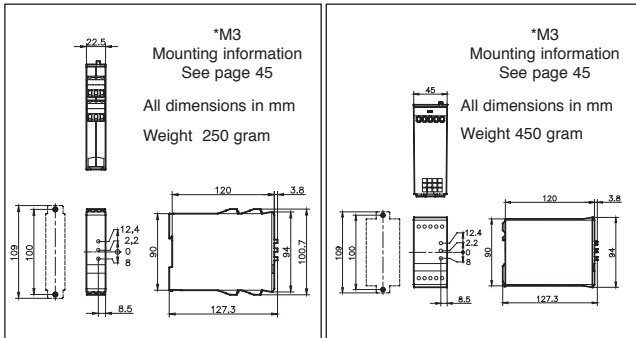

Dimensions 22.5 mm module (MAUX / SC 1 15 A)

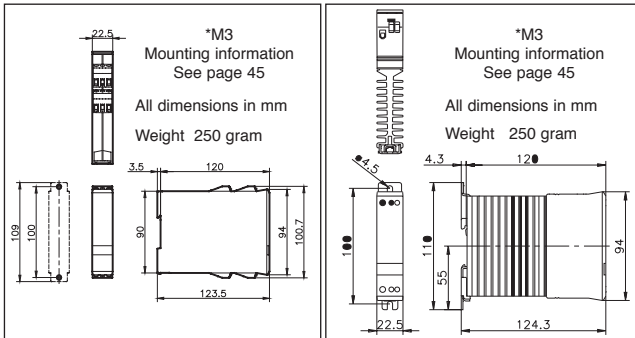

Dimensions 45 mm module (SC/RC/SRC/SMC3/15A STL /SPC 30A)

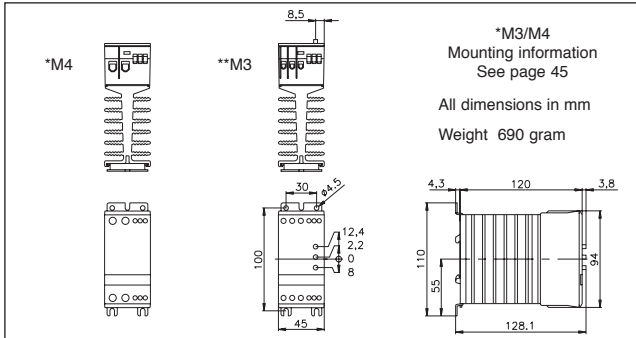

Dimensions 90 mm module (Contactors, SPC 50A)

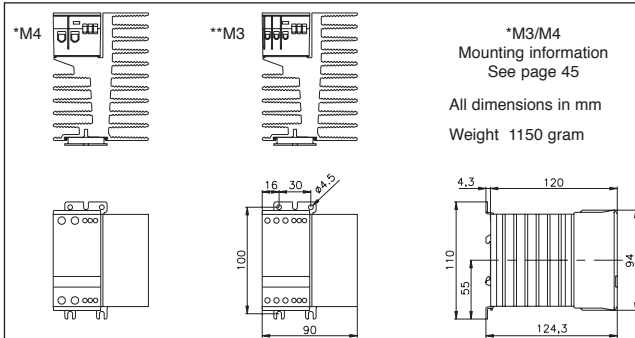

Dimensions 90 mm module (SMC3/33 SMBC 3)

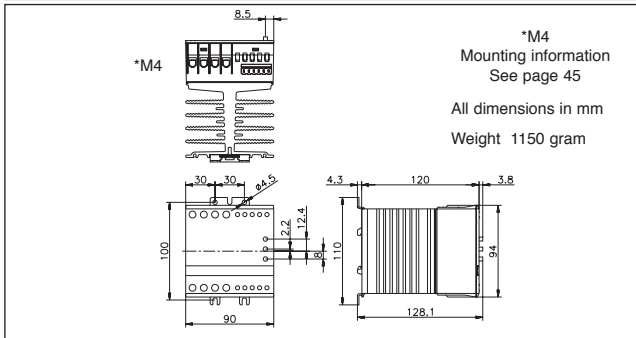

Dimensions 180 mm module (SMC33)

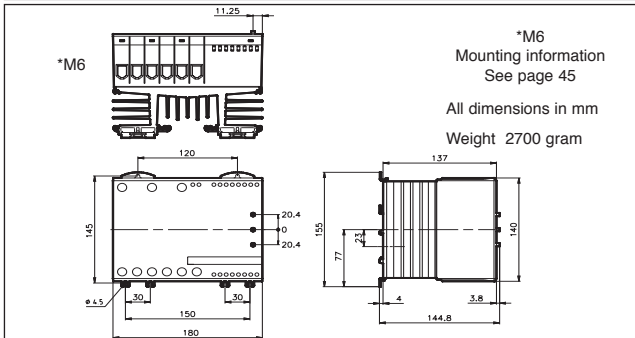

Mounting instructions all Modules. All units with heatsink are designed for vertical mounting. If the units are mounted horizontally the load current must be reduced to 50% of the rated current.

Current change (SMC 3 XX03)

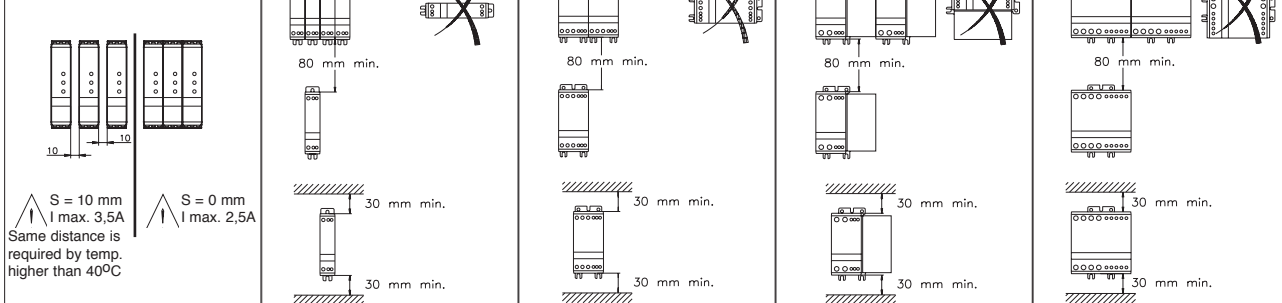

Humidity: The relative humidity of the air may not exceed 50% at a maximum temperature of + 40 0C. Higher relative humidities may be permitted at lower temperatures, e.g. 90% at + 20°C. Special measures may be necessary in cases of occasional condensation due to variations in temperature.

Materials: Housing: Self-extinguishing PPO UL94V1. Halogen free **DIN rail adaptor:** For 35 mm rails EN 50022 **Heatsink:** Aluminium. Black anodized **Base:** Electroplated steel **Vibrations:** EN60068-2-6: 5g 10 - 150 Hz

Thermal overload protection UP62

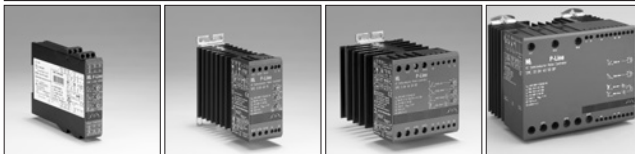
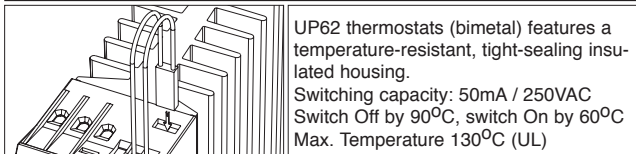

Dimensions, weight, mounting and wiring instruction

Wiring connections (Module 22.5 / 45 / 90 mm)

Wiring type with or without cable / sleeves and other type of terminals * UL tested									
L1 T1 / L2 T2 / L3 T3 *M4 Power terminals	1 x 1,5 - 6 mm ²	2 x 1,5 - 6 mm ²	1 x 1,5 - 10 mm ²	2 x 1,5 - 6 mm ²	1 x 1 - 10 mm ²	2 x 1 - 6 mm ²	N.A.	Pozidriv 2 1.2 Nm Max.	6 mm 1,2 Nm Max.
L1 T1 / L2 T2 / L3 T3 **M3 Power terminals	1 x 0,75 - 4 mm ²	2 x 1.0 mm ²	1 x 0,75 - 6 mm ²	2 x 0,75 - 2.5 mm ²	1 x 0,75 - 6 mm ²	2 x 0,75 - 1.5 mm ²	N.A.	Pozidriv 1 0.5 Nm Max.	4 mm 0,5 Nm Max.
A1 A2 / 11 12 Input terminals	1 x 0,5 - 1.5 mm ²	2 x 0,5 - 0,75 mm ²	1 x 0,5 - 1.5 mm ²	2 x 0,5 - 1.5 mm ²	1 x 0,5 - 1.5 mm ²	2 x 0,5 - 1.5 mm ²	N.A.	N.A.	3 mm 0,5 Nm Max.

Wiring connections (Module 180 mm)

Wiring type with or without cable / sleeves and other type of terminals									
L1 T1 / L2 T2 / L3 T3 *M6 Power terminals	1 x b4 - b35 mm ²	2 x b2 - b16 mm ²	1 x a4 - a35 mm ²	2 x a4 - a10 mm ²	1 x a4 - b50 mm ²	2 x b4 - b16 mm ²	N.A.	Pozidriv 3 a4.0 Nm* b5.5 Nm* Max.	N.A.

***Important: When using electric or pneumatic tools for screw terminals observe the maximum torque limits**

GENERAL TECHNICAL INFORMATION

Fuse overview related to I²t values for each item. Co-ordination Type 2

In connection with the protection of soft starters and electronic contactors use of semiconductor fuses will protect the semiconductor inside the product in case of short circuits and reduce the potential of SCR damage due to transient overload currents. Fuses e.g. from Ferraz, Siba, Bussmann can provide you with suitable fuses. When selecting fuses ensure that the fuse has a lower total clearing I²t rating than the SCR as indicated under each type in this catalogue and that the fuse is able to carry the start current for the actual start duration.
Normal fuses can be used to protect the installation (co-ordination type 1) in case of short circuit. See the actual useable fuse values as informed under each product.

Overload current profile in accordance with EN60947-4-2

Overload current profile (AC-53a without by-pass contactor) = X-Tx:8-3:100-3000

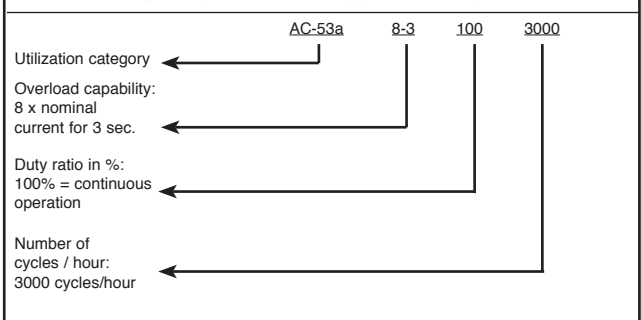

Overload current profile (AC-53b with by-pass contactor) = X-Tx:6-6:30

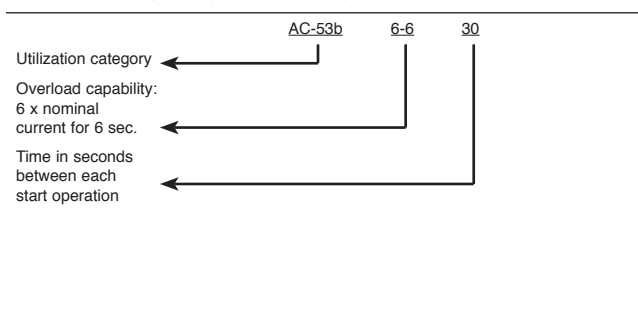

Utilization category explanation

AC-52a: Control of slip ring motor stators / **AC-52b:** Control of slip ring motor stators with the controller bypasses during running / **AC-53a:** Control of squirrel cage motors / **AC-53b:** Control of squirrel cage motors with the controller bypasses during running / **AC-58a:** Control of hermetic refrigerant compressors with automatic resetting of overload releases / **AC-58b:** Control of hermetic refrigerant compressors with the controller bypassed during running and with automatic resetting of overload releases.

NOTE: The means of bypassing the semiconductor controller may be integral with the controller/starter or installed separately.

Index

Item Number	EAN Number 57 05 609....	Page	Item Number	EAN Number 57 05 609....	Page
1 & 3 Phases Soft Starter					
SMC 33 DA 2350BP	001 964	6-7	SC 1 DD 4063	001 742	22-23
SMC 33 DA 2385DBP	001 995	6-7	SC 1 DA 4063	001 711	22-23
SMC 33 DA 4015	001 803	6-7	SC 1 DD 6015	001 247	22-23
SMC 33 DA 4025 BP	001 834	6-7	SC 1 DA 6015	001 216	22-23
SMC 33 DA 4040 DBP	001 865	6-7	SC 1 DD 6030	000 325	22-23
SMC 33 DA 4050 BP	001 971	6-7	SC 1 DA 6030	000 301	22-23
SMC 33 DA 4085 DBP	002 008	6-7	SC 1 DD 6050	000 332	22-23
SMC 3 DA 2303	001 582	8-9	SC 1 DA 6050	000 318	22-23
SMC 3 DA 4003	001 599	8-9	SC 1 DD 6063	001 759	22-23
SMC 3 DA 4803	001 605	8-9	SC 1 DA 6063	001 728	22-23
SMC 3 DA 6003	001 612	8-9	SC 1 DD 6915	003 012	22-23
SMC 3 DA 2315	000 271	8-9	SC 1 DA 6915	003 098	22-23
SMC 3 DA 4015	000 288	8-9	SC 1 DD 6930	003 050	22-23
SMC 3 DA 6015	000 424	8-9	SC 1 DA 6930	003 067	22-23
SMC 3 DA 2325	000 448	8-9	SC 1 DD 6950	003 074	22-23
SMC 3 DA 4025	000 462	8-9	SC 1 DA 6950	0030 81	22-23
SMC 3 DA 6025	000 479	8-9	SC 1 DD 6963	003 029	22-23
SMC 3 DA 2325 BP	001 407	8-9	SC 1 DA 6963	002 923	22-23
SMC 3 DA 4025 BP	001 414	8-9	1-Phase electronic contactor for ohmic loads		
SMC 3 DA 6025 BP	001 421	8-9	RC 11 DD 2310	002 152	24-25
SMC 32 DA 4015 BP	002 497	8-9	RC 11 DD 2315	002 169	24-25
STL 1 - 1215	001 896	12-13	RC 11 DA 2315	002 077	24-25
STL 1 - 1225	001 902	12-13	RC 11 DD 2330	002 176	24-25
STL 1 - 4015	001 919	12-13	RC 11 DA 2330	002 084	24-25
STL 1 - 4025	001 926	12-13	RC 11 DD 2350	002 183	24-25
STL 1 - 6015	001 933	12-13	RC 11 DA 2350	002 091	24-25
STL 1 - 6025	001 940	12-13	RC 11 DD 2363	002 190	24-25
STL 3 - 1215	001 773	12-13	RC 11 DA 2363	002 107	24-25
STL 3 - 1225	001 780	12-13	RC 11 DD 4015	002 206	24-25
STL 3 - 4015	000 295	12-13	RC 11 DA 4015	002 114	24-25
STL 3 - 4025	000 486	12-13	RC 11 DD 4030	002 213	24-25
STL 3 - 6015	000 493	12-13	RC 11 DA 4030	002 121	24-25
STL 3 - 6025	000 509	12-13	RC 11 DD 4050	002 220	24-25
STL 3 - 6925	000 547	12-13	RC 11 DA 4050	002 138	24-25
Soft Starter with Dynamic Brake			RC 11 DD 4063	002 237	24-25
SMBC 3 DA 2325	001 148	14-17	RC 11 DA 4063	002 145	24-25
SMBC 3 DA 4025	001 155	14-17	1-Phase electronic contactor (for domestic applications)		
3-Phase electronic reversing contactor			SC 1 DA 2330 L	001 070	26-27
SRC 3 DD 4010	000 257	18-19	SC 1 DA 2350 L	001 087	26-27
SRC 3 DA 4010	000 264	18-19	SC 1 DA 4030 L	001 094	26-27
3-Phase electronic motor contactor (Direct On Line)			1-Phase dual pole electronic contactor		
SMC 3 DA 2315 DOL	000 523	20-21	SC 2 DD 2330	000 097	28-29
SMC 3 DA 4015 DOL	000 455	20-21	SC 2 DA 2330	000 103	28-29
SMC 3 DA 6015 DOL	000 516	20-21	SC 2 DD 2350	000 110	28-29
1-Phase electronic contactor			SC 2 DA 2350	000 127	28-29
SC 1 DD 2315	001 223	22-23	SC 2 DD 4030	000 134	28-29
SC 1 DA 2315	001 193	22-23	SC 2 DA 4030	000 141	28-29
SC 1 DD 2330	000 011	22-23	SC 2 DD 4050	000 158	28-29
SC 1 DA 2330	000 028	22-23	SC 2 DA 4050	000 165	28-29
SC 1 DD 2350	000 035	22-23	SC 2 DD 6030	000 363	28-29
SC 1 DA 2350	000 042	22-23	SC 2 DA 6030	000 349	28-29
SC 1 DD 2363	001 735	22-23	SC 2 DD 6050	000 370	28-29
SC 1 DA 2363	001 704	22-23	SC 2 DA 6050	000 356	28-29
SC 1 DD 4015	001 230	22-23			
SC 1 DA 4015	001 209	22-23			
SC 1 DD 4030	000 059	22-23			
SC 1 DA 4030	000 066	22-23			
SC 1 DD 4050	000 073	22-23			
SC 1 DA 4050	000 080	22-23			

Index

Item Number	EAN Number 57 05 609...	Page
1 -Phase dual pole electronic kontaktor for ohmic loads		
RC 22 DD 2330	002 282	30-31
RC 22 DA 2330	002 244	30-31
RC 22 DD 2350	002 299	30-31
RC 22 DA 2350	002 251	30-31
RC 22 DD 4030	002 305	30-31
RC 22 DA 4030	002 268	30-31
RC 22 DD 4050	002 312	30-31
RC 22 DA 4050	000 275	30-31
3 -Phase electronic kontaktor for ohmic loads		
RC 32 DD 4015	002 428	32-33
RC 32 DA 4015	002 404	32-33
RC 32 DD 4025	002 435	32-33
RC 32 DA 4025	002 411	32-33
3 -Phase electronic kontaktor		
SC 3 DD 2310	000 172	34-35
SC 3 DA 2310	000 189	34-35
SC 3 DD 2320	000 196	34-35
SC 3 DA 2320	000 202	34-35
SC 3 DD 4010	000 219	34-35
SC 3 DA 4010	000 226	34-35
SC 3 DD 4015	003 036	34-35
SC 3 DA 4015	003 043	34-35
SC 3 DD 4020	000 233	34-35
SC 3 DA 4020	000 240	34-35
SC 3 DD 6010	000 400	34-35
SC 3 DA 6010	000 387	34-35
SC 3 DD 6020	000 417	34-35
SC 3 DA 6020	000 394	34-35
3 -Phase electronic kontaktor for ohmic loads		
RC 33 DD 2310	002 367	36-37
RC 33 DA 2310	002 329	36-37
RC 33 DD 2320	002 374	36-37
RC 33 DA 2320	002 336	36-37
RC 33 DD 4010	002 381	36-37
RC 33 DA 4010	002 343	36-37
RC 33 DD 4020	002 398	36-37
RC 33 DA 4020	002 350	36-37
1 -Phase electronic kontaktor analogue power controller		
SPC 1 AD 2330	001 100	38-39
SPC 1 AD 2350	001 117	38-39
SPC 1 AD 4030	001 124	38-39
SPC 1 AD 4050	001 131	38-39
Auxiliary contact module		
MAUX 01 A 600	001 629	42-43
Thermal overload protection		
UP 62	000 530	44
Dimensions, weight, mounting and wiring instruction		
All types		44-45
Index		46-47

AUSTRALIA
Mechtric Pty Ltd
14 Lorries Court
AU-6944 Malaga WA
PO Box 2584
Perth-Australia
Tlf: +61 8 9248 0410
Fax: +61 8 9248 0401
www.mechtric.com.au
sales@mechtric.com.au

AUSTRIA
Schrack Technik GmbH
Seybelgasse 13
A-1230 Wien
Tlf: +43 1 866 85 5900
Fax: +43 1 866 85 98801
www.schrack.com
export@schrack.com

BELGIUM
Bintz technics
Brixtonlaan 23
B-1930 Zaventem
Tlf: +32 2 720 49 16
Fax: +32 2 720 37 50
www.bintz.be
info@bintz.be

DENMARK
Elteco A/S
Valløvej 3
DK-7400 Herning
Tlf: +45 70 25 18 45
Fax: +45 70 25 18 55
www.elteco.dk
info@elteco.dk

DENMARK
Solar Danmark A/S
Industrivej Vest 39
DK-6600 Vejen
Tlf: +45 76 96 12 00
Fax: +45 76 97 12 09
www.solar.dk

ESPANA
Intertronic Internacional S.L.
C/Johannes Gutenberg 4 y 6
Pl.Parque Tecnológico
E-46980 Paterna
Tlf: +34 96 375 80 50
Fax: +34 96 375 10 22
www.intertronic.es
info@intertronics.es

FINLAND
Gycom Finland Oy
Pakkalantie 30 A
FI-01530 VANTAA, Finland
Tlf: +358 9 2525 21 00
Fax: +358 9 2525 21 77
www.gycom.com

FRANCE
ACINC
11 rue Denis Papin
07200 AUBENAS
Tlf: +33 (0)4 75 36 39 08
Fax: +33 (0)4 75 36 39 07
www.acinc.fr
contact@acinc.fr

GERMANY
abel-technik e.k
Friedrichstr. 41
D-26203 Wardenburg
Tlf: +49 44 07 9139 350
Fax: +49 44 07 9139 351
www.abel-technik.de
info@abel-technik.de

GERMANY
GESAA mbH & Co KG
Johann-Hittorf-Strasse 6
DE-12489 Berlin
Tlf: +49 30 4058 5320
Fax: +49 30 404 3150
www.gesaa.de
info@gesaa.de

GERMANY
RFD electronic GmbH
An der Kanzel 2
DE-97253 Gaukönigshofen
Tlf: +49 93 37 97 12-30
Fax: +49 93 37 97 12-450
www.rfd-electronic.de
info@rfd-electronic.de

GERMANY
Vispa
Luhdorfer Str. 39
DE-21243 Winsen (Luhe)
Tlf: +49 4171 710 13
Fax: +49 4172 710 16
www.vispa.de
vispa@vispa.de

GREECE
KALAMARAKIS - SAPOUNAS S.A.
IONIAS & NEROMILOU STR.
GR-136 71 CHAMOMILO
ACHARNES - Athen
Tlf: +302 10 240 6000 6
Fax: +302 10 240 6007
kalamarakis.sapounas@ksa.gr

ICELAND
ISKRAFT
Smiöjuvegur 5
IS-200 Kópavogur
Tlf: +354 535 1200
Fax: +354 535 1201
www.iskraft.is

IRELAND
Industrial Solutions Ltd.
4A Dunshaughlin Business Centre
IE-Dunshaughlin Co. Meath
Tlf: +353 (1) 825 9969
Fax: +353 (1) 825 9373
www.industrialsolutions.ie
info@industrialsolutions.ie

ITALY
SIT s.p.a.
Viale A. Volta, 2
IT-20090 Cusago Mi
Tlf: +39 02 89 14 41
Fax: +39 02 89 14 42 91
www.sitronic.it
sitronic@sitspa.it

NETHERLANDS
VIERPOOL B.V.
Industrieweg 2
NL-3606 AS Maarsen
Tlf: +31 346 59 45 11
Fax: +31 346 57 40 55
www.vierpool.nl
info@vierpool.nl

NORWAY
STORK AS
Brynsveien 100
N-1352 Kolsås
Tlf: +47 67 17 64 00
Fax: +47 67 17 64 01
www.stork.no

POLAND
DACPOL Co. Ltd
Pulawska 34
PL-05-500 Piaseczno
Tlf: +48 22 70 35 100
Fax: +48 22 70 35 101
www.dacpol.com.pl
dacpol@dacpol.com.pl

PORTUGAL
Bresimar Automação, S.A
Quinta do Simão - EN 109 - Esgueira
Apartado 3080
PT-3801-101 Aveiro
Tlf: +351 234 303 320
Fax: +351 234 303 328/9
www.bresimar.pt
bresimar@bresimar.pt

ROMANIA
SYSCOM srl
Protopescu 10, bl. 4, ap.2
RO-71255 Bucharest
Tlf: +401 310 2678
Fax: +401 222 9176
www.syscom.ro
syscom@syscom.ro

SCHWEIZ
Comat AG
Bernstrasse 4
CH-3076 Worb
Tlf: +41 31 838 55 77
Fax: +41 31 838 55 99
www.comat.ch
info@comat.ch

SOUTH AFRICA
ELECTROMECHANICA (PTY) LTD
9/11 Data Crescent, Ormonde Ext 8
P.O. Box 38980
ZA-Booyens 2016, Johannesburg
Tlf: +27 11 249 5 000
Fax: +27 11 496 2778
www.em.co.za

SWEDEN
Gycom Svenska AB
Stockholmsvägen 116
Box 1203
SE-183 12 TÄBY, Sverige
Tlf: +46 8 632 30 00
Fax: +46 8 792 06 54
www.gycom.se

SWEDEN
KIT AB
Arlövsvägen 10
SE-211 24 Malmö, Sverige
Tlf: +46 40 44 00 41
Fax: +46 40 44 0369
www.kitab.se
info@kitab.se

TAIWAN - CHINA
DAYBREAK INTERNATIONAL (TAIWAN) CORP.
3FL, No. 124, Chung-Cheng Road,
Shihlin 11145, Taipei, Taiwan
Tlf: +886-2-8866-1234
Fax: +886-2-8866-1239
www.daybreak.com.tw
day111@ms23.hin.net

TURKEY
4S Elektrik Elektronik
Telekomünikasyon Ith.
Ihr.Paz.Tic.Ltd.Sti.
Kuyumcukent Kompleksi Atölye Blogu
1.Kat.10. Sk.No:25 Yenibosna / ISTANBUL
Tlf: +90 850 223 47 62
Fax: +90 850 228 08 73
www.4sLtd.com.tr
odivarci@4sLtd.com.tr

UKRAINE
RTS UKRAINE
JS Real Time Systems Ukraine
29a, 29b Chkalova St.,
UA-49070 Dnepropetrovsk, Ukraine, CIS
Tlf: +38 056 770 04 00
Fax: +38 0562 32 47 59
www.rst.ua
eam@rts.ua

UNITED KINGDOM
TAKBRO Ltd
Albert Drive
Burgess Hill
GB-West Sussex RH15 9DN
Tlf: +44 1444 87 23 01
Fax: +44 1444 87 23 16
www.takbro.com
sales@takbro.co.uk

USA
SPRINGER CONTROLS inc.
96074 Chester Road Yulee
Florida 32097
Tlf: +1 904 225 0575
Fax: +1 904 225 9084
www.springercontrols.com
info@springercontrols.com

 **IC ELECTRONIC A/S**

Eksportvej 7-9 · Laurbjerg
DK-8870 Langaa · Denmark
Phone: +45 70 23 49 44
Fax: +45 70 23 49 24

E-mail: info@ic-electronic.com
www.ic-electronic.com

Distributor: